



Nolt's Greenhouse Supplies

A division of Nolt's Produce Supplies, LLC

Specializing in Greenhouse Growing Supplies and Structures

2025 Commercial Growers Catalog

Join us at Nolt's Produce Supplies new facility
on December 11th and 12th 2024 for our
Annual CUSTOMER APPRECIATION DAYS

Now located across the road from our facility.

• Meal & Refreshments • Show Specials • Prizes
*Greenhouse and produce supply vendors will be
displaying their products and answering questions.*

Visit us at MANTS (booth #2104) Jan 8-10, 2025

**151 E Farmersville Rd
Ephrata, PA 17522**

Phone: (717) 354-8376

Early Order Discounts:

NOVEMBER 2024 SALE: 8% cash discount
on orders prepaid by November 30, 2024

December 1, 2024 to January 3rd, 2025:
4% cash discount on prepaid orders

Jan - Oct 2025: 2% cash discount on prepaid orders

Discount Applies To All Prices In This Catalog
Discounts for Credit Card Sales are 2% less than above.

Store Hours

Monday – Friday:

7:00 AM – 5:00 PM all year.

Saturdays: Closed July - October

November - June: 8:00 AM - 12:00 PM

Closed Sunday and on all Christian Holidays
including Good Friday, April 18, 2025
And Ascension Day, Thursday, May 29, 2025

Welcome!

Our mission is to provide commercial growers with quality horticultural supplies and service at a fair price. We offer only proven products based on our experience and your feedback. With 35+ years in business, we are constantly expanding our inventory & staff to serve you better. In 2016 we opened this location. All our greenhouse related products are at this location. All our produce related products and seeds are at [Nolt's Produce Supplies](#) which is now located directly across the street.

We strive to stock all products listed. Unfortunately sometimes there's unforeseen supply & demand changes that result in shortages, or extended lead times. We reserve the right to refuse orders for any items in short supply that you haven't been buying historically. Returning customers are our priority. We reserve the right to prorate any items in short supply. Product specifications and prices are subject to change without notice and substitute products may occasionally be shipped.

We encourage you to submit your orders a few weeks before pickup or ship date, to allow us time to process your order. Please pickup orders no later than the month after ordering. Orders after 30 days will be subject to available supply and price.

Upon receiving your order please inspect it immediately and report any error, shortage or damage within 10 days. We constantly strive to meet or exceed your expectations by carefully packaging and processing your order. However, we are all human, and errors can occur. If you wait to inspect your order until the day you want to use the product, it is difficult to determine where the error occurred. [Nolt's Greenhouse Supplies](#) is not responsible for shortages reported more than 10 days after receipt.

Returns: Saleable products may be returned with permission and may be subject to handling charges based on the condition and time of return for seasonal products. Expired products, special order, and non-stock items are **not** returnable.

Credit Invoices: In the case of overpayments, cancellations, shortages, returns, defective products, etc. credit invoices will be issued. Credit invoices not used will be mailed twice a year, but may be subject to deletion after 15 months.

All prices are FOB Ephrata, PA (except items with indicated FOB point) and are subject to change without notice. Contact us for pricing discounts on large quantity orders.

Thank you for your continued support and another successful year! Wishing you God's blessings in the new growing season.

Terms	Shipping Options
COD or Check in advance.    	 9 to 5 Delivery Service Serving Lancaster County, PA.  We also offer UPS Next Day Air and other expedited shipping options.  When shipping LTL motor freight we compare prices among numerous carriers to find the best rates.

Map

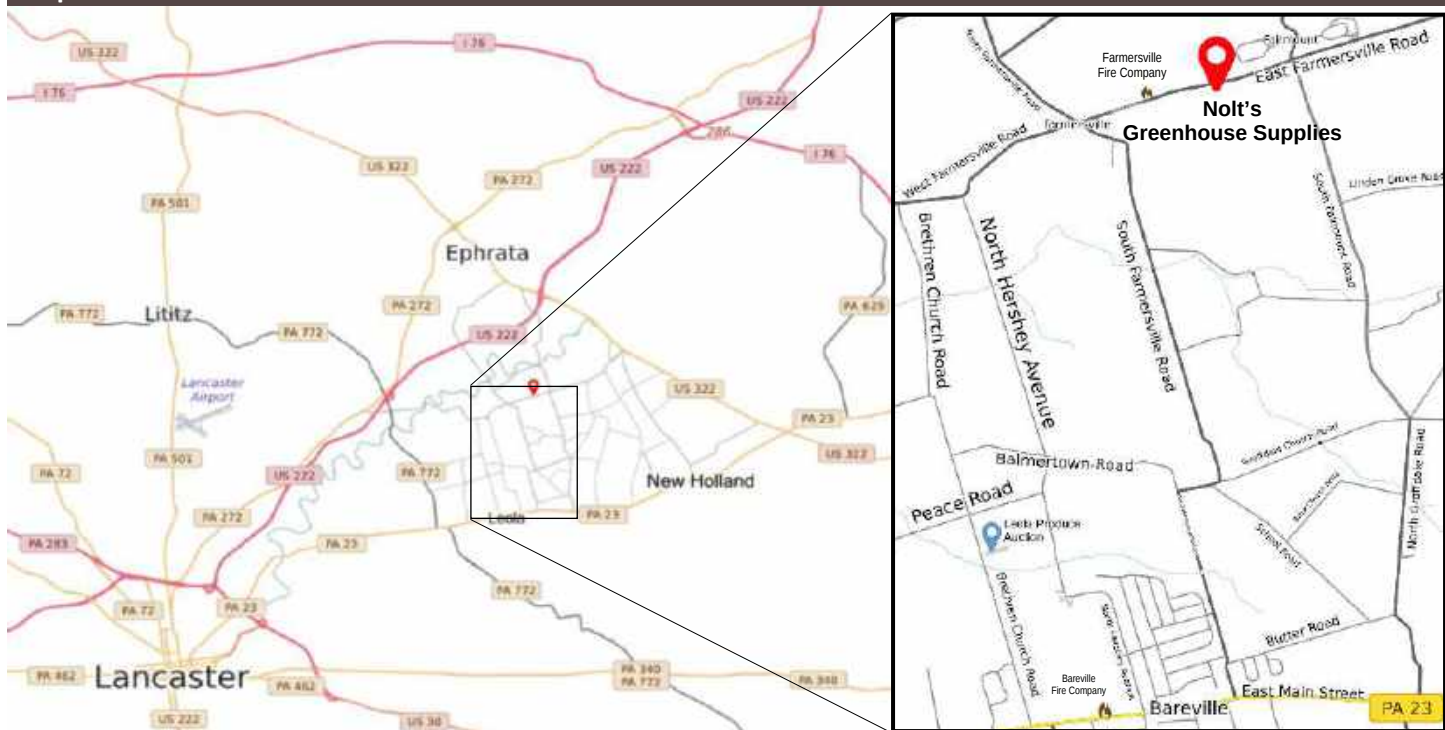

Index

A	
Acids.....	22
Alarm Systems.....	45
Aluminum Extrusions.....	38
Aluminum Shutters.....	43
Azalea Pots.....	11
B	
Backpack Sprayers.....	25
Battery Controllers & Valves....	29
Batten Tape.....	38
Bench Tops & Components.....	7
Black Ground Cover.....	35
Black Poly Pipe.....	30
Brace Bands.....	39
Brass Hose Fittings.....	20
C	
Cable Ties.....	39
Calcium Nitrate.....	22
Carts.....	36
Carrying Trays.....	8, 17
Chemical Safety Products..	25, 25
Clamps.....	26
Clear Plastic.....	37
Coconut Coir.....	5
Controlled Release Fertilizer....	22
Controllers & Valves.....	29
Convection Fan and Tubing.....	44
Corrugated Retail Flats.....	17
Cross Connectors.....	39
Curtain Rope & Strapping.....	40
D	
Decorative Pots, Planters.....	16
Dan Foggers.....	32
Dan Micro-Sprinklers.....	33
Disinfectant.....	21
Doors.....	42
Dramm Foggers.....	23
Drip Hose & Fittings.....	30, 32
Drip Tape & Fittings.....	30, 32
Drippers.....	31
E	
Electric Controllers & Valves....	29
Electric Sprayers.....	25
Epsom Salt.....	22
Extension Handles.....	19
Extension Hangers.....	39
F	
Fabric Clips.....	40
Fans.....	43
Fertilizer.....	22
Fertilizer Injectors.....	24, 25
Filters.....	28
Fittings, Drip Tape.....	32
Fittings, Garden Hose.....	20
Fittings, Nipples & Unions.....	26
Fittings, Orchard Tubing.....	32
Fittings, Plastic Insert.....	26
Fittings, Sch40.....	27
Flat Filler.....	6

Flower Pouches.....	21
Foggers.....	23, 32, 51
Frost Blanket.....	35
Fungicide.....	23
G	
Galvanized Wire Mesh.....	7
Galvanized Tubing.....	39, 46
Garden Hose & Fittings.....	19, 20
Geranium Pots.....	11
Gear Cranks.....	41
Gloves.....	21
Greenhouse Accessories...	19-21
Greenhouse Pots.....	10-13
Greenhouse Doors.....	42
Greenhouse Equipment....	37-42
Greenhouse Frames....	46, 47, 48
Greenhouse Hardware.....	37-46
Greenhouse Plastic.....	37
Greenhouse Roll Up Sides	40-41
Greenhouse Sprinklers.....	33, 34
Ground Cover & Staples.....	35
Grow Lights, LED.....	34
H	
Handi-reach Handles.....	19
Hanging Baskets.....	14, 15, 18
Heaters.....	44
Heating Mats, Agritape.....	21
Hose.....	19, 30
Humidity Domes.....	21
Hydrants.....	28
I	
Inflation Blowers.....	37
Insect Monitoring Cards.....	21
Insert Fittings.....	26, 27, 28
Inserts (packs).....	8, 17
Irrigation Hose.....	19, 30
J	
Jiffy 7's & Jiffy Strips.....	15
K	
Kool Ray Shade.....	35
L	
Layflat.....	30
LED Grow Lights.....	34
M	
Market Packs.....	17
Micro-Sprinklers.....	33
Modine Heaters.....	44
Mum Pans.....	12
N	
Nursery Containers, Trays.....	13
O	
Orchard Tubing & Fittings..	30, 32
Oval Hose.....	30
P	
Perlite.....	5
Pipe.....	27, 30
Pipe Straps.....	39
Pipe Cutters.....	27
Plant Transport Carts.....	36
Plastic Bench Tops.....	7
Plastic Plant Labels.....	12

Plug Flats & Sheets.....	9
Poly Patch Tape.....	37
Polycarbonate Sheeting.....	38
Potting Mixes.....	4, 5
Pots & Planters.....	10-18
Press Fit Pots & Trays.....	10
Pressure Gauges.....	26
Pressure Regulators.....	28
Pro-Mix.....	4, 5
Purlin Pipe.....	40, 46
PVC Cement.....	27
PVC Nipples & Unions.....	26
PVC Pipe.....	27
R	
Rice Hulls.....	5
Roll Up Sides.....	40, 41
Rooting Powder.....	23
S	
S Hooks.....	39
Sch40 Pipe & Fittings.....	27
Sch80 Nipples & Unions.....	26
Screen Filters.....	28
Screws, Stainless Steel.....	7, 39
Seeder & Seedling Trays.....	8, 9
Sensaphone.....	45
Shade Cloth & Paint.....	35
Sharpie Markers.....	12
Sheet of Pots.....	10
Shutters.....	43
Side Clasp Roll Bar.....	40
Siphon Mixer.....	19
Snips & Scissors.....	51
Soluble Fertilizer.....	22
Spaghetti Tubing.....	31
Spray Stakes.....	31
Sprayers.....	25
Square Tubing.....	39
Stainless Steel Clamps.....	26
Sticky Traps.....	21
T	
T&H Mixes.....	4
Temperature Alerts.....	45
Thermoformed pots.....	11, 13
Thermostats.....	44
Transport Trays.....	10, 11, 13
Trellises.....	51
Tubing.....	30, 31
Tufflite Greenhouse Plastic.....	37
U	
Underground Pipe.....	30
V	
Valves, Brass & PVC.....	28
Valves, Electric.....	29
Valves, Garden Hose.....	20
Valves, PVC Union.....	28
Vermiculite.....	5
W	
Water-Matic Trays.....	10
Watering Nozzles, etc.....	19
Wire Mesh.....	7
WireLock.....	38

Quick Find

Potting Mixes & Peat Moss 4-6

Benching 7

Pots & Containers 8-18

Greenhouse Supplies 19-21

Fertilizer 22

Injectors & Sprayers 23-25

Irrigation & Fittings 26-34

Covers 35

Carts 36

Greenhouse Components 37-42

Fans & Heaters 43-44

Alarm Systems 45

Greenhouses 46-48



Pro-mix BX

A general purpose peat-based growing mix. Contains starter nutrients and is PH adjusted.

Ingredients: Sphagnum peat moss (80-85%); Perlite; Vermiculite; Limestone (pH adjuster); Wetting Agent. Our most popular mix.



3.8 Cu. Ft. Compressed Bale Ship Weight 68+ lb

Item #	Description	1-9	10-29	30/Skid
PM-138N	BX Original	\$32.00	\$31.35	\$30.70
PM-138	BX with Mycorrhizae	\$32.80	\$32.15	\$31.50
PM-138P	BX with Biofungicide + Mycorrhizae	\$34.35	\$33.70	\$33.00

2.8 Cu. Ft. Loose Bag Ship Weight 32+ lb

Item #	Description	1-9	10-56	57/Skid
PM-130	BX with Mycorrhizae	\$16.20	\$15.85	\$15.50
PM-130P	BX with Biofungicide + Mycorrhizae	\$16.75	\$16.40	\$16.00

Pro-mix MPX (Formerly LP15)

An economical general purpose peat-based growing mix with moderate porosity. Now with Mycorrhizae. **Ingredients:** Canadian sphagnum peat moss (85-90%); Perlite (10-12%); Limestone (pH adjuster); Wetting Agent.



3.8 Cu. Ft. Compressed Bale Ship Weight 65+ lb

Item #	Description	1-9	10-29	30/Skid
PM-P38	MPX with Mycorrhizae	\$28.65	\$28.00	\$27.35

Pro-mix HP (High Porosity)

A peat-based growing mix with good drainage, high air porosity and low water retention. **Ingredients:** Sphagnum peat moss (70-75%); Perlite (25-30%); Limestone (pH adjuster); Wetting Agent.

3.8 Cu. Ft. Compressed Bale Ship Weight 70+ lb

Item #	Description	1-9	10-29	30/Skid
PM-438P	HP with Biofungicide + Mycorrhizae	\$35.50	\$34.80	\$34.10

Pro-mix MPO Organic

An OMRI-Listed multi-purpose peat-based growing mix. **Ingredients:** Canadian sphagnum peat moss (65-70%), Coir; Perlite; Calcitic Limestone (pH adjuster); Gypsum; Organic Fertilizer - Soya based; Organic Wetting Agent.



3.8 Cu. Ft. Compressed Bale Ship Weight 70+ lb

Item #	Description	1-9	10-29	30/Skid
PM-538P	MPO with Biofungicide + Mycorrhizae	\$39.25	\$38.50	\$37.80

What is Biofungicide? *Bacillus pumilus (GHA180)*

Biofungicide is a naturally occurring strain of bacteria that combats harmful organisms such as Fusarium, Pythium and Rhizoctonia. Helps prevent root diseases and damping-off. The bacteria also act as a biostimulant that enhances the establishment and the development of the root system, leading to more uniform plant stands.

What is MYCORRHIZAE™? (*Glomus intraradices*)

Mycorrhizae is a biological growth enhancer that is found naturally in soils around the world. Benefits:

- More efficient acquisition of water and nutrients.
- Improved plant survival after planting into field and garden soil.
- Increased crop vigor, plant quality and quantity of flowers/fruit.

Pro-mix FPX (Germination Mix)

This fine grind mix is designed for plug growing and germination. **Ingredients:** Canadian sphagnum peat moss, plug grade (80-90%); Fine Perlite; Limestone (pH adjuster); Wetting Agent.

2.8 Cu. Ft. Loose Bag Ship Weight 32+ lb

Item #	Description	1-9	10-56	57/Skid
PM-630B	FPX with Biofungicide	\$18.60	\$18.20	\$17.80

T&H TH-1

An all purpose professional growing.

Ingredients: Canadian sphagnum peat moss (81.25%), coarse perlite (13.75%), coarse vermiculite (5%), calcitic lime, dolomitic lime, wetting agent and starter fertilizer with trace elements. Comparable to Pro-mix BX Original.



Item #	Description	1-9	10-29	30/Skid
TH-TH1	TH-1	\$28.75	\$28.10	\$27.45

T&H P-15

An economical general purpose growing medium with moderate-high porosity.

Ingredients: Canadian sphagnum peat moss (85%), coarse perlite (15%), calcitic lime, dolomitic lime, wetting agent and starter fertilizer with trace elements.

Comparable to Pro-mix LP15 and ASB GM15.



3.8 Cu. Ft. Compressed Bale Ship Weight 65+ lb

Item #	Description	1-9	10-29	30/Skid
TH-P15	P-15	\$25.65	\$25.00	\$24.40

ASB Greenworld GM15

An economical general purpose growing medium with moderate porosity. **Ingredients:** fertilizer, wetting agent, extra starter charge, 85% Canadian sphagnum peat moss and 15% perlite. Comparable to Pro-mix LP15 or T&H P15.

Other ASB mixes available upon request.



3.8 Cu. Ft. Compressed Bale Ship Weight 65+ lb

Item #	Description	1-9	10-29	30/Skid
AG-GM15	GM15	\$25.65	\$25.00	\$24.40

Contact us for additional discounts on 3 or more skids. Free shipping on half and full truckloads of any Pro-mix, T&H and ASB products.



Pro-mix BK25

PRO-MIX BK25 is a medium-weight growing medium designed for the cultivation of greenhouse horticultural crops in 4" pots or larger. The combination of processed southern pine bark (25%), sphagnum peat moss (55%) and perlite makes for a general purpose product that provides good drainage and low water retention capacity. Also contains limestone and wetting agent.



2.8 Cu. Ft. Loose Bag Ship Weight 45+ lb

Item #	Description	1-9	10-47	48/Skid
PM-BK25N	BK25 Original	\$14.35	\$14.00	\$13.65

60 Cu. Ft. Tote Ship Weight 900+ lb

Item #	Description	1	2/Skid
PM-BK25N60	BK25 Original	\$330.00	\$314.00

Pro-mix BK55

PRO-MIX BK55 is a medium-weight growing medium designed for the cultivation of long-term greenhouse crops and perennials grown outdoors. The combination of processed southern pine bark (55%), sphagnum peat moss (30%) and perlite makes for a good air/water balance. The high percent of bark adds weight, which is perfect for growers looking for container stability. Also contains limestone and wetting agent.



2.8 Cu. Ft. Loose Bag Ship Weight 65+ lb

Item #	Description	1-9	10-41	42/Skid
PM-BK55N	BK55	\$14.50	\$14.15	\$13.80

60 Cu. Ft. Tote Ship Weight 1,100+ lb

Item #	Description	1	2/Skid
PM-BK55N60	BK55	\$335.00	\$319.00

Rice Hulls (Parboiled)

PBH Nature's Media Amendment is a uniquely processed rice hull product from Riceland Foods, Inc. with multiple uses in greenhouses and nurseries. Compressed packaging generates less waste, lowers freight costs and minimizes storage and handling. WSDA registered.



PBH as a media amendment: PBH is the perfect replacement for perlite in the growing media. Less dusty than perlite.

PBH as a container topdress: Significantly improves weed control for just pennies per container.



Item #	Description	Yield	Wt.	1-15	16/Skid
RH50	Parboiled Rice Hulls	7 Cu. Ft.	50#	\$16.25	\$15.00

Pro-mix Retail Potting Mix

Do you sell retail plants or have a garden center? If so, your customers will love this mix. Ideal for seed starting applications. Suitable for potting and repotting plants. Ingredients: Canadian sphagnum peat moss; Peat humus; Polymer Gel (to hold extra water); Perlite; Limestone; Controlled release fertilizer (lasts up to 9 months); Mycorrhizae - GHA297 technology.



Other retail mixes available upon request.

Item #	Description	1-9	10-53	54/Skid
PMR1020	Retail Mix, 2 cu. Ft.	\$12.45	\$12.10	\$11.75

Sold in full skid quantity only.

Item #	Description	Price/Bag	Bags/Skid
PMR1010	Retail Potting Mix, 1 cu. Ft	\$6.55	120=\$786.00

Sold in packs of 6

Item #	Description	1-9 pks	10-34 pks	35/Skid
PMR1016	Retail Potting Mix, 16 qt. (0.53 cu. Ft)	\$36.00/pk	\$35.10/pk	\$34.20/pk
		\$6.00 ea.	\$5.85 ea.	\$5.70 ea.

Pro-mix Peat Moss

PRO-MOSS "HORT" Sphagnum peat moss.



3.8 Cu. Ft. Compressed Bale Ship Weight 60+ lb

Item #	Description	1-9	10-29	30/Skid
PM-338	Peat Moss	\$15.00	\$14.40	\$13.80

Coconut Coir

This 12" x 12" x 6" block yields 2 to 2.5 Cu. Ft. loose. With easy wet expansion. Coir is used as soil amendment with peat and perlite. Or in place of peat moss for soilless potting mixes. Less acidic than peat and has a higher water retention.



1/2 Cu. Ft. Compressed Block Ship Weight 11+ Lb

Item #	Description	1-99	100-219	220/Skid
CC02	Individually Wrapped	\$7.00	\$6.65	\$6.30
CC02B	Bulk skid of 220 Blocks	\$1320.00 = \$6.00 ea Bulk Only		

Vermiculite & Perlite

Horticultural grade. Both vermiculite and perlite are used in to prevent soil compaction, improve aeration and retain moisture. Vermiculite acts more like a sponge, holding more water than perlite and offering less aeration. Perlite retains water on its surface, but it is porous and allows excess water to drain more readily than vermiculite and improves soil aeration.



Item #	Description	Bag Size	1-29	30/Skid
TOV2	Vermiculite, Medium	4 Cu. Ft.	\$23.00	\$21.75
TOV3	Vermiculite, Fine	4 Cu. Ft.	\$20.60	\$19.50

Item #	Description	Bag Size	1-29	30/Skid
TOP6	Perlite, Coarse	4 Cu. Ft.	\$17.80	\$16.75

Contact us for additional discounts on 3 or more skids. Free shipping on half and full truckloads of any Pro-mix products.

Media Master™ Pot & Flat Filler

This versatile machine features both a bale buster and a pot/flat filler. Requires single phase 230VAC. Pre-wired with plug. Full load: 14 amps.

Pot/flat filler features: Fills pots/flats up to 14" wide and up to 12" tall. The leveler assembly height is easy & quick to adjust via a winch. The distribution chute is adjustable to evenly fill the pots & trays. Water-resistant control panel features variable speed controls for the conveyer and for the supply auger.

Bale buster features: A series of rotating arms (pictured under the bale buster listing below) that quickly and thoroughly mix and loosen soil in less than a minute.

Capacity of 21 cu. ft. Loose (3=3.8 cu. ft. compressed bales). Thorough mixing allows you to add additional product to your mix (root shield, fungicide etc). Convenient fill height of 34".

Overall Dimensions: 113" width x 48" depth x 70" heights.

Shipping Weight: about 950 lbs. Order early to ensure availability.



Have questions or need something custom-made on the filler or bale buster? Available in Hydraulic, Air and Mechanical drive. For more information call us, or the manufacturer: Wilmer Hoover Ph: 717-859-1164

Item #	Description	Price
MM 2100	Model 2100 Pot/Flat Filler	\$10,250.00



Rear view



Leveling roller and brush assembly



Control box and plug configuration



Media Master™ Bale Shaver & Water Tunnel On custom order basis: Bale Shaver for 110-135 cu ft towers & water tunnels to be used as stand-alone, or in line with flat filler. Optional top dress applicator and/or tray sanitizer. Call for info and pictures.

Media Master™ Bale Buster

Features a hopper with a capacity of 14 cu. ft. loose (2=3.8 cu. Ft. comp. bales).

Full load: 10.3 amps. Has a series of rotating arms that mix and loosen soil in less than a minute. Thorough mixing allows you to add additional product to your mix (root shield, fungicide etc). Convenient fill height of 34". The supply auger & filling chute allows you to easily fill pots and trays manually. Variable speed controls are optional, however typically not needed.

Requires single phase 230VAC. Pre-wired and ready to plug in.

Overall Dimensions: 54" width x 48" depth x 69" heights.

Shipping Weight: about 675 lbs. Order early to ensure availability.

Item #	Description	Price
MM 1400	Model 1400 Bale Buster	\$6,280.00



Detail of mixing arms



Detail of filling auger and chute



The Media Master™ Bale Buster now comes standard with caster wheels, similar to what is pictured on the Pot & Flat Filler above.

Plastic Bench Tops, A-V International

- Polypropylene, UV protected
- Durable and lightweight, no sagging
- Can withstand extremely cold and hot temperatures
- Installs on any type of frame with screws or pop rivets
- Frame every 2 feet for flats, or pots less than 3 gallon.
- Easy interlocking assembly
- Flats, plug trays, and pots slide easily over surface
- Easy to clean and disinfect
- Will not rust or decay
- Inorganic, prevents the growth of mold and fungus
- No protruding wires or jagged metal edges
- Easy, positive interlocking feature on 48" sides, no clips required



Item #	Description	1-77	78+
PBT2448	24" x 48" Plastic Bench Tops	\$14.75	\$14.05
Item #	Description	1-175	176+
PBT1836	18" x 36" Plastic Bench Tops	\$9.60	\$9.10



We can help you with all your benching needs. Assemble your own for around \$4-5 per square foot by using plastic bench tops & the components listed below. With these materials you will have a bench that lasts a long time, maybe even a lifetime. A cheaper option is using 2x4s with plastic bench tops or wire mesh. We can quote on complete bench systems.

Greenhouse Benches

Heavy-duty galvanized square tubing frame with reinforced smooth corners, SS fasteners and A-V plastic bench tops (above) makes this bench exceptional durable. Plastic bench tops prevent the growth of mold and fungus and outlast most other types of benches. For shipping/transport purposes we sell the benches without legs. Use below leg kits, or for easy to stow benches use cement blocks. Made in-house. Call for prices on custom sizes.

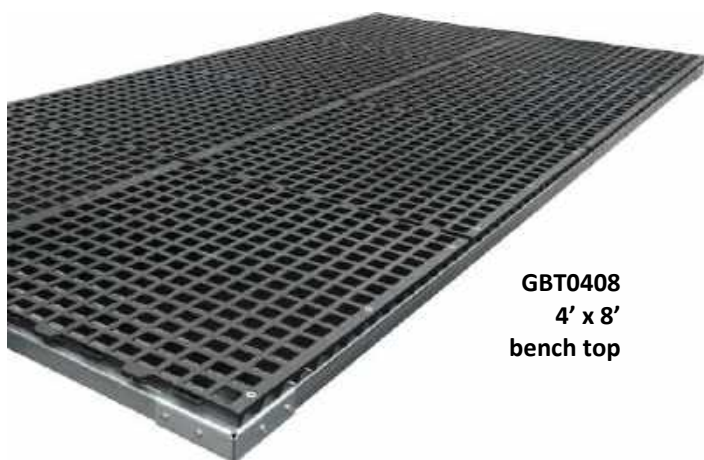

GBT0408
4' x 8'
bench top

Item #	Description	1-9	10+
GBT0408	4' x 8' Bench Tops	\$156.00	\$148.00
GBT0410	4' x 10' Bench Tops	\$183.00	\$174.00
GBT0412	4' x 12' Bench Tops	\$210.00	\$200.00
GBT0414	4' x 14' Bench Tops	\$239.00	\$228.00
Leg Kits Include: 4 legs and all hardware to install & brace			
GBL24	24" Leg Kit	\$75.00	\$70.00
GBL30	30" Leg Kit	\$77.00	\$72.00
GBL36	36" Leg Kit	\$80.00	\$75.00

Bench Components

Build your own heavy-duty benches using these parts and plastic bench tops or galvanized wire mesh.

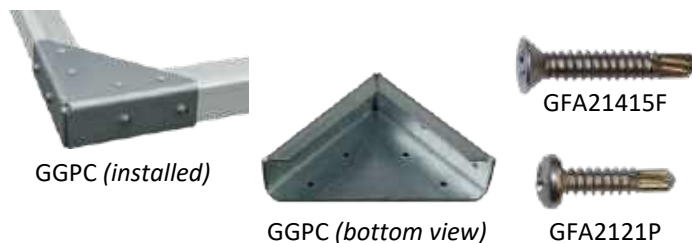

Item #	Description	Price
GGPS152416	1.5" x 24' Sq Galvanized Tubing, 16 Ga.	\$37.00
GGPA	Metal Angle to fasten center support	\$0.55
GGPC	Galvanized Corner Bracket, designed to add strength and smoothen the corner	\$4.30
GFA2121P	#12 x 1" 410SS Pan Head Tek Screw To fasten corner and angle brackets	\$15.50 100/Pk
GFA21415F	#14 x 1-1/2" 410SS Flat Head Tek Screw To fasten plastic bench tops	\$15.00 50/Pk
GGPB	1 x 12" Aluminum Brace, use 2 per leg	\$2.60

Galvanized Wire Mesh

This heavy-duty, 12.5 gauge, 1" x 2" rectangles, galvanized wire mesh is great for greenhouse bench tops.

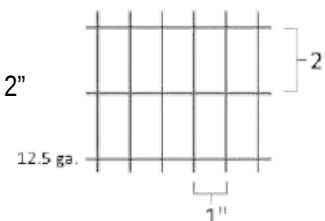

Item #	Description	Price
GWM04	4' x 100' Galvanized Wire Mesh	\$500.00
GWM06	6' x 100' Galvanized Wire Mesh	\$735.00



L Series Packs (Inserts) Standard 1020 Size

Call for full skid pricing.

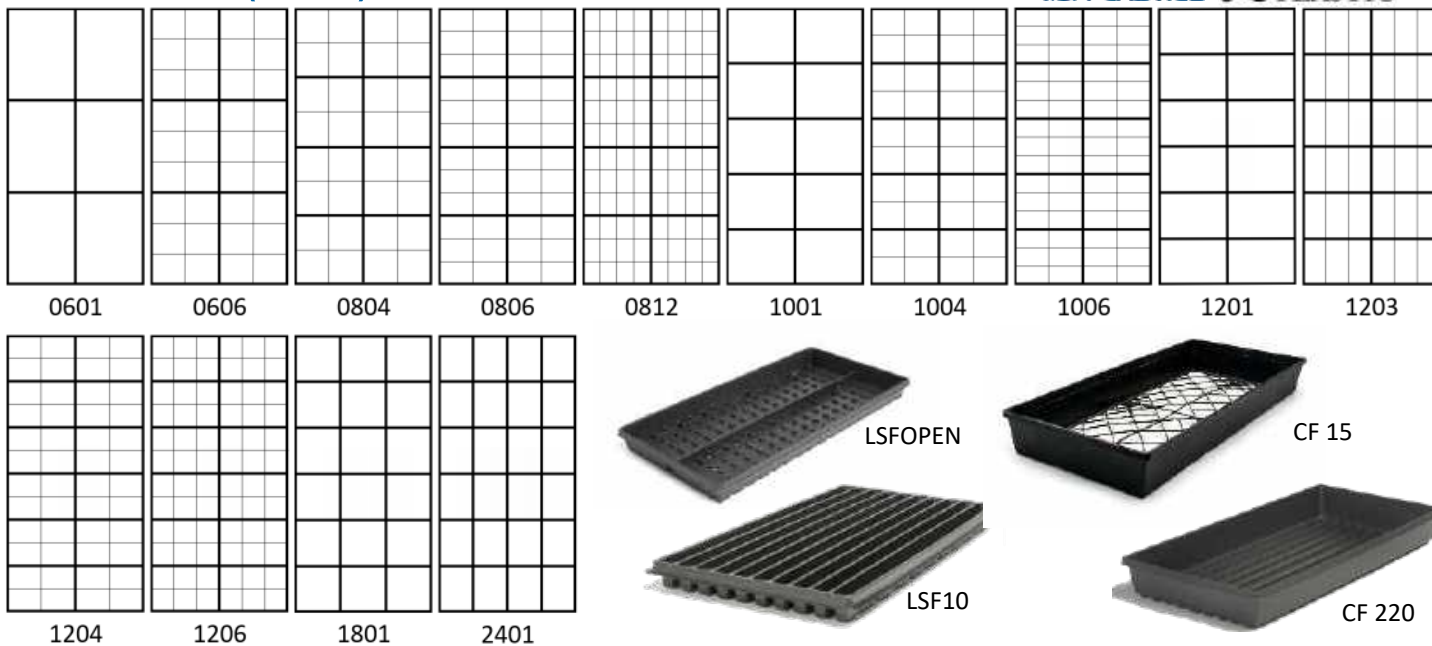

L Series Packs (Inserts) Standard 1020 Size (20.85" x 10.42") Perforated and easy to tear apart.					Skid Qty	Mfg Code	Cell Dimensions			Pack Volume	
Item #	Description	Sheets/Cs	1-5 Cs	6+ Cs			Length	Width	Depth	Liquid	Cu. In.
IN 0601	601, 6 packs of 1 cell	100	\$59.50	\$58.00	54	STI-601	6.44	4.85	2.33	1.13 qt	65.05
IN 0606	606, 6 packs of 6 cells	100	\$53.50	\$52.00	32	L606	2.35	2.15	2.33	1.91 pt	55.10
IN 0804	804, 8 packs of 4 cells	100	\$52.50	\$51.00	32	L804	2.35	2.35	2.33	1.48 pt	42.72
IN 0806	806, 8 packs of 6 cells	100	\$52.50	\$51.00	32	L806	2.35	1.55	2.33	1.34 pt	38.81
IN 0812	812, 8 packs of 12 cells	100	\$59.50	\$58.00	56	STI-812	1.52	1.13	2.33	-	-
IN 1001	1001, 10 packs of 1 cell	100	\$59.50	\$58.00	32	STI-1001	4.80	3.85	2.33	-	-
IN 1004	1004, 10 packs of 4 cells	100	\$52.50	\$51.00	63	L1004	2.40	1.85	2.33	1.09 pt	31.44
IN 1006	1006, 10 packs of 6 cells	100	\$53.50	\$52.00	32	L1006	1.85	1.75	2.33	0.99 pt	28.63
IN 1201	1201, 12 packs of 1 cell	100	\$59.50	\$58.00	32	STI-1201	4.85	3.15	2.33	1.01 pt	29.29
IN 1203	1203, 12 packs of 3 cells	100	\$59.50	\$58.00	32	L1203	3.15	1.55	2.33	0.89 pt	25.81
IN 1204	1204, 12 packs of 4 cells	100	\$52.50	\$51.00	32	L1204	2.35	1.45	2.33	0.87 pt	25.14
IN 1206	1206, 12 packs of 6 cells	100	\$53.50	\$52.00	32	L1206	1.55	1.55	2.33	0.75 pt	21.60
IN 1801	1801, 18 packs of 1 cell	100	\$56.50	\$55.00	32	L1801	3.10	3.10	2.33	0.64 pt	18.55
IN 2401	2401, 24 packs of 1 cell	100	\$56.50	\$55.00	32	L2401	3.10	2.25	2.33	0.44 pt	12.75

L Series Super Jumbo/Deep Packs, Stnd 1020 Size (20.85" x 10.42") Perforated and easy to tear apart.					Skid Qty	Mfg Code	Cell Dimensions			Pack Volume	
Item #	Description	Sheets/Cs	1-5 Cs	6-31 Cs			Length	Width	Depth	Liquid	Cu. In.
INJ0606	606, 6 packs of 6 cells	100	\$54.50	\$53.00	32	L606SJ	2.35	2.15	3.13	1.29 qt	74.69
INJ0804	804, 8 packs of 4 cells	100	\$55.50	\$54.00	32	L804SJ	2.46	2.47	3.05	1.55 pt	44.44
INJ0806	806, 8 packs of 6 cells	100	\$55.50	\$54.00	32	L806SJ	2.35	1.60	3.12	1.64 pt	47.27
INJ1204	1204, 12 packs of 4 cells	100	\$55.50	\$54.00	32	L1204D	2.63	1.72	2.75	1.02 pt	29.41

L Series Trays, Carrying Trays and Seeder Trays (Standard 1020 size)

Item #	Description	Pcs/Cs	1-5 Cs	6+ Cs	Skid Qty	Mfg Code	Length	Width	Depth
CF 15	Medium Weight Solid Side, Web Bottom New & improved mold! Even better fit.	50	\$36.50	\$35.00	54	IL1020ISSN	21.00	10.50	2.50
CF 2	Heavy Duty, Almost Solid Side, Web Bottom	50	\$48.50	\$47.00	48	694213	21.10	10.55	2.40
CF 22	NCR Tray, Solid Side with Bottom Drain Holes	100	\$76.00	\$74.00	40	710245C	21.22	10.80	2.33
CF 220	NCRN Tray, Solid Side and Bottom, NO Holes	100	\$77.00	\$75.00	40	710251C	21.22	10.80	2.33
CF 22HD	NCR Tray, Solid Side with Bottom Drain Holes, same as CF 22, but 50% thicker plastic	75	\$90.00	\$88.00	32	L1020NCR- HD	21.22	10.80	2.33
LSFOPEN	Open Seeder Tray, Solid Side, Slitted Bottom	100	\$124.00	\$121.00	32	136ST	21.22	10.80	1.38
LSF10	10 Row Seeder Tray, Solid Side, Slitted Bottom	100	\$168.00	\$164.00	32	PSEED10	21.50	11.00	1.25



Plug Sheets



Plug Sheets (20.85" x 10.42") Standard 1020 Size (Lightweight, to use with a carrying tray)								Cell Configuration	Top Diameter	Cu. In. Per Cell
Item #	Description	Pcs/Cs	1-5 Cs	6+ Cs	Skid Qty	Mfg Code	Depth			
LPSR0240	24 Round	100	\$70.00	\$68.00	32	24PSD	2.75	3 x 8 Staggered	2.63	8.17
LPSR038	38 Round	100	\$70.00	\$68.00	32	38PS	2.38	2@7 and 3@8	2.25	6.80
LPSR050	50 Round	100	\$61.00	\$59.00	32	50PS	2.38	5 x 10	2.00	4.60
LPSR072	72 Round	100	\$63.00	\$61.00	32	72PS	2.38	6 x 12	1.50	2.54
LPSR098	98 Round	100	\$80.00	\$78.00	32	98PS	1.63	7 x 14	1.38	1.69
LPS018	18 SQUARE	100	\$63.00	\$61.00	32	18SPSD	3.23	3 x 6	3.16	23.42
LPS050	50 SQUARE	100	\$99.50	\$97.00	40	725616C	2.38	5 x 10	1.93	5.80
LPS072	72 SQ. w/Root Channels	100	\$64.00	\$62.00	32	72SPS	2.38	6 x 12	1.63	4.09

Plug Trays

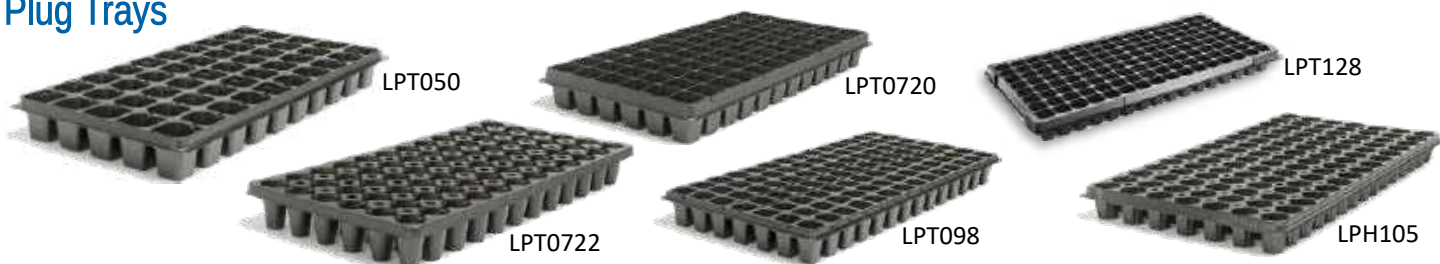

Plug Flats (21.38" x 11.05") Standard 1020 Size (Heavy-duty, to use without a carrying tray)								Cell Config.	Top Diameter	Cu. In. Per Cell
Item #	Description	Pcs/Cs	1-5 Cs	6+ Cs	Skid Qty	Mfg Code	Depth			
LPT050	50 Square	100	\$118.00	\$115.00	24	P50	2.25	5 x 10	1.75	5.19
LPT0720	72 Square, Deep	100	\$101.00	\$98.00	24	PL-072	2.38	6 x 12	1.63	4.45
LPT0722	72 Round w/Vent Holes	100	\$101.00	\$98.00	32	72FPT	2.25	6 x 12	1.49	2.52
LPT098	98 Square	100	\$108.00	\$105.00	32	P98	2.00	7 x 14	1.25	1.92
LPT128	128 Square	100	\$95.00	\$92.00	32	P128	2.00	8 x 16	1.25	1.68
LPT200	200 Square	100	\$101.00	\$98.00	32	P200	1.75	10 x 20	0.88	1.29
LPT288	288 Square	100	\$115.00	\$112.00	24	P288SQ	1.00	12 x 24	0.75	0.44
LPT288D	288 Square, Deep	100	\$123.00	\$120.00	24	P288SQD	1.75	12 x 24	0.75	0.61
LPT392	392 Square	100	\$125.00	\$122.00	32	P392	1.00	14 x 28	0.63	0.28
LPT512	512 Square	100	\$104.00	\$101.00	20	P512	1.00	16 x 32	0.56	0.24

Hexagon Plug Flats, Standard 1020 Size (Heavy-duty, to use without a carrying tray)								Cell Config.	Top Diameter	Cu. In. Per Cell
Item #	Description	Pcs/Cs	1-5 Cs	6-31 Cs	Skid Qty	Mfg Code	Depth			
LPH105	105 w/Root Channels	100	\$103.00	\$100.00	32	105HEX	1.5	7 x 15	1.25 x 1.38	1.4

Seedling Trays



Seedling Trays (21.23" x 10.8") Standard 1020 Size (HD, to use without carrying tray)								Cell Config.	Top Dia.	Cu. In. Per Cell
Item #	Description	Pcs/Cs	1-5 Cs	6+ Cs	Skid Qty	Mfg Code	Depth			
LST030	30 Ct Rose pot shape w/ channels	50	\$76.00	\$74.00	32	30ST	3.50	2@8 & 2@7	2.50	10.50
LST038	38 Ct Rose pot shape w/ channels	50	\$91.50	\$89.00	20	38ST	5.00	3@8 & 2@7	2.25	12.10
LST050	50 Ct Octagonal w/ round bottom	55	\$94.50	\$92.00	20	50ST	4.50	5 x 10	1.88	8.80
LST072	72 Ct Rose pot shape w/ channels	50	\$79.00	\$77.00	32	72ST	3.25	6 x 12	1.63	4.20

Please contact us for pricing on full skid quantities. We also give additional discounts for large orders. Please call for detailed quote.



Square Pots



Press Fit, Landmark Plastics							Stock color: Black		Dimensions		Volume		Compatible
Item #	Description	Pcs/Cs	1-5 Cs	6+ Cs	Skid Qty	Mfg Code	Dia.	Depth	Liquid	Cu. In.	Transport Trays		
PF 0225	2.25 Square	1,920	\$83.00	\$81.00	36	225P	2.19	3.00	0.306 pt	8.85	PF-10225		
PF 03	3.00 Square	800	\$40.00	\$39.00	52	3PF800	2.63	2.25	0.375 pt	10.8	PF-1030		
PF 030	3.00 Square Deep	800	\$39.50	\$38.50	48	3PD800	2.63	3.50	0.59 pt	17.09	PF-1030		
PF 0320	3.25 Sq. Extra Deep	400	\$31.00	\$30.00	72	3PXD400	3.00	4.25	0.83 pt	23.98	PF-10320		
PF 040	4.00 Square	450	\$36.00	\$35.00	48	SVD 350	3.50	3.50	1.05 pt	30.33	PF-1040		
PF 0400	4.00 Sq. Extra Deep	450	\$49.50	\$48.00	32	4PXD	3.50	5.02	1.52 pt	43.94	PF-1040		
PF 045	4.50 Square	375	\$38.50	\$37.50	28	45P375	4.19	3.63	1.69 pt	48.82	PF-1045,12 or 10		
PF 0450	4.50 Square Deep	375	\$47.50	\$46.00	28	45PD375	4.19	4.88	1.15 qt	66.64	PF-1045,12 or 10		

Black w/Label Slots, Belden Plastics							Dimensions		Volume		Compatible
Item #	Description	Pcs/Cs	1-5 Cs	6+ Cs	Skid Qty	Mfg Code	Dia.	Depth	Liquid	Cu. In.	Transport Trays
BSP0450	4.50 Jumbo Jr Square	375	\$94.00	\$92.00	28	691525	4.13	5.00	1.05 qt	N/A	PF-1045,12 or 10
BSP05	5.25 Jumbo Square	200	\$90.00	\$88.00	40	6915150	5.25	5.25	1.71 qt	N/A	L Series 1020 (fits loose)
BSP050	5.25 Jumbo Senior	200	\$94.00	\$92.00	40	691535	5.25	6.50	2.03 qt	N/A	L Series 1020 (fits loose)
BSP06	6.00 Magnum Square	150	\$89.00	\$87.00	40	691543	6.00	6.50	2.79 qt	N/A	BST06

Pots & Containers

Sheet of Pots



Items on these pages, Call for full skid pricing.

Lightweight pots in a perforated sheet, Landmark Plastics							Dimensions		Volume		Compatible
Item #	Description	Pcs/Cs	1-5 Cs	6+ Cs	Skid Qty	Mfg Code	Diameter	Depth	Liquid	Cu. In.	Transport Trays
LSP030	3.00 Square, 32 Count	100	\$73.00	\$71.00	24	3SQSP	2.45 x 2.47	3.00	0.387 pt	11.17	LSP1030, L Series
LSP0350	3.50 Sq. Deep, 18 Ct	100	\$79.00	\$77.00	20	35SPXD	3.48 x 3.47	3.50	0.92 pt	26.55	PF-1040, L Series
LSP045	4.50 Square, 15 Count	100	\$135.00	\$132.00	16	45SP	4.09 x 4.09	3.65	1.55 pt	44.85	PF-1045

Square Pot Trays



Square Pot Trays							Dimensions			Compatible
Item #	Description	Pcs/cs	1-5 Cs	6+ Cs	Skid Qty	Mfg Code	Length	Width	Depth	Square Pots
PF 10225	2.25 Sq. Pot Tray, 32 Count	100	\$87.50	\$85.00	40	2SPT32	18.10	9.12	2.25	PF-0225
PF 1030	3.00 Sq. Pot Tray, 32 Count	100	\$85.50	\$83.00	32	LPF32TRY	21.23	10.79	1.50	PF-03, PF-030
LSP1030	3.00 Sheet of Pots Tray, 32 Ct	100	\$95.50	\$93.00	32	3SPT32	21.23	10.79	2.00	LSP030
PF 10320	3.25 Sq. Extra Deep Tray, 20 Ct	100	\$109.00	\$106.00	36	3PXDT20	15.19	12.19	2.00	PF-0320
PF 1040	4.00 Sq. Pot Tray, 18 Count	50	\$39.50	\$38.50	48	SPT 350	21.25	10.81	1.93	PF-040, PF-0400
PF 1045	4.50 Sq. Pot Tray, 15 Count	50	\$52.50	\$51.00	32	LPF15TRY	21.10	12.71	2.31	PF-045, PF-0450, BSP0450
PF 104512	4.50 Sq. Pot Tray, 12 Count	100	\$98.50	\$96.00	20	L45PF12	16.97	12.75	2.31	PF-045, PF-0450, BSP0450
PF 104510	4.50 Sq. Pot Tray, 10 Count	90	\$71.00	\$69.00	30	45SPT10	20.94	8.44	2.02	PF-045, PF-0450, BSP0450
BST05	Jumbo Sq. Pot Tray, 8 Count	50	\$193.00	\$188.00	18	698140	21.25	10.90	3.25	BSP05, BSP050 fits loose
BST06	Magnum Sq. Pot Tray, 6 Count	50	\$155.00	\$151.00	18	694225	18.00	12.00	3.25	BSP06

Water Collector Trays & Sheets

Holds water while elevated holes drain excess water.



Poinsettia growers find LWC14 saves a lot of watering time.

Item #	Description	Pcs/cs	1-5 Cs	6-31 Cs	Mfg Code	Length	Width	Depth	Compatible Pots
LWM45	4.50 Rnd/Sq Tray, 8 Ct 2x4 spaced	100	\$147.50	\$144.00	45RSWM	20.25	10.13	2.44	All 4.5" Square & Round
LWC14	14" Water Collector, 2 Ct sheet	100	\$168.00	\$164.00	W14X14	28.25	14.13		All 8" round w/5.5" base



Round Thermoformed Pots



Flexible sidewall with rim design that has good hoop strength.

Item #	Description	Pcs/Cs	1-5 Cs	6+ Cs	Skid Qty	Mfg Code	Dimensions		Volume		Compatible Trays
							Dia.	Depth	Liquid	Cu. In.	
TWT40	4.00 Round, Black	825	\$54.50	\$53.00	42	4RMGT	4.0"	3.49	1.02 pt	29.4	SRT040
TWT45	4.50 Geranium, Black	450	\$42.25	\$41.00	48	45RMGT	4.5"	4.02	1.37 pt	39.7	SRT045-12-10
TWT45TC	4.50 Geranium, Terra-Cotta	450	\$66.50	\$65.00	48	45RMGT	4.5"	4.02	1.37 pt	39.7	SRT045-12-10
TWT50	5.00 Azalea, Black	440	\$46.25	\$45.00	48	5AMGT	5.0"	3.61	1.67 pt	48.21	SRT050
TWT50TC	5.00 Azalea, Terra-Cotta	440	\$67.50	\$66.00	48	5AMGT	5.0"	3.61	1.67 pt	48.21	SRT050
TWT60	6.00 Azalea, Black	220	\$32.50	\$31.50	48	6AMGT	6.0"	4.38	1.40 qt	81.04	SRT060
TWT60TC	6.00 Azalea, Terra-Cotta	220	\$44.25	\$43.00	48	6AMGT	6.0"	4.38	1.40 qt	81.04	SRT060
TWT65	6.50 Azalea, Black	240	\$36.00	\$35.00	48	65AMGT	6.5"	5.00	2.08 qt	120.12	SRT065
TWT65TC	6.50 Azalea, Terra-Cotta	240	\$49.50	\$48.00	48	65AMGT	6.5"	5.00	2.08 qt	120.12	SRT065
TWT75	7.50 Azalea, Black	220	\$52.50	\$51.00	27	75AMGT	7.5"	5.71	3.02 qt	174.5	

Round Injection Molded Pots



Heavy Duty, Rigid							Dimensions		Volume		Compatible Trays
Item #	Description	Pcs/Cs	1-5 Cs	6+ Cs	Skid Qty	Mfg Code	Dia.	Depth	Liquid	Cu. In.	
TWP030C	Clay 3.00 Standard	1,750	\$156.00	\$152.00	28	Koba	3"	2.75	7.0 fl oz	12.63	SRT030
TWP045	Black 4.50 Azalea	750	\$108.00	\$105.00	28	Koba	4.5"	3.63	1.28 pt	37.90	SRT045-12-10
TWP045G	Green 4.50 Azalea	750	\$109.00	\$106.00	28	Koba	4.5"	3.63	1.28 pt	37.90	SRT045-12-10
TWP060	Black 6.00 Azalea	387	\$120.00	\$117.00	18	Koba	6"	4.50	1.25 qt	72.19	SRT060
TWP060G	Green 6.00 Azalea	387	\$121.00	\$118.00	18	Koba	6"	4.50	1.25 qt	72.19	SRT060
TWP065	Black 6.50 Azalea	246	\$75.00	\$73.00	28	Koba	6.5"	5.13	1.66 qt	115.52	SRT065
TWP065G	Green 6.50 Azalea	246	\$76.00	\$74.00	28	Koba	6.5"	5.13	1.66 qt	115.52	SRT065
TWP070	Green 7.00 Azalea	264	\$115.00	\$112.00	28	Koba	7"	5.50	2.16 qt	151.62	
TWP080	Green 8.00 Azalea	206	\$108.00	\$105.00	18	Koba	8"	6.25	1.00 gal	231.04	
TWP100	Green 10.00 Azalea	36	\$39.00	\$38.00	40	Koba	10"	7.50	1.75 gal	404.32	
TWP120	Black 12.00 Azalea	25	\$77.00	\$75.00	42	Belden	12"	9.00	3.00 gal	0.00	

Round Pot Transport Trays



Round Pot Transport Trays			Price Per Case				Dimensions			Compatible Pots
Item #	Description	Pcs/cs	1-5 Cs	6+ Cs	Skid Qty	Mfg Code	Length	Width	Depth	
SRT030	3.00 12 Count 3x4	130	\$203.00	\$198.00	28	Koba	12.00	9.00	3.00	TWP030C
SRT040	4.00 15 Count 3x5	100	\$120.00	\$117.00	18	4TP15PS	20.25	12.13	3.50	TWT4
SRT04010	4.00 10 Count 2x5	75	\$60.00	\$58.00	40	LN4TP10	20.38	8.13	3.72	TWT4
SRT045	4.50 15 Count 3x5	90	\$146.00	\$142.00	16	45TPPP	23.06	14.06	3.94	TWT45, TWP045
SRT04512	4.50 12 Count 3x4	75	\$92.50	\$90.00	24	45TP12	18.99	14.11	3.96	TWT45, TWP045
SRT04510	4.50 10 Count 2x5	75	\$69.00	\$67.00	40	45TP10	22.40	8.90	4.19	TWT45, TWP045
SRT050	5.00 8 Count 2x4	100	\$107.00	\$104.00	36	T5TP	20.00	10.00	3.75	TWT5
SRT060	6.00 6 Count 2x3	100	\$103.00	\$100.00	30	6TP	17.64	11.50	4.25	TWT6, LTW060
SRT065	6.50 6 Count 2x3	100	\$121.50	\$118.00	28	65TP	19.63	13.00	5.25	TWT65, TWP065



Mum Pans

Call for full skid pricing.



Pot sleeves for 9" mum pots. To protect the plants and save space during transport. Item # PS09 100/Pack with wire carrier. \$24/Pack

Thermoformed has a flexible sidewall with rim design that has good hoop strength							Dimensions		Volume	
Item #	Description	Pcs/Cs	1-5 Cs	6+ Cs	Skid Qty	Mfg Code	Dia.	Depth	Liquid	Cu. In.
TWT85	8.00 Black, Thermoformed	130	\$37.50	\$36.00	30	8MPMGT	8.0	5.0	3.04 qt	175.44
TWT85T	8.00 Terra-Cotta, Thermoformed	130	\$46.50	\$45.00	30	8MPMGT	8.0	5.0	3.04 qt	175.44
MUM85	8.00 Green, Injection Molded	258	\$248.00	\$242.00	25	IMP800	8.0	5.0	3.09 qt	178.5
TWT96	9.00 Black, Thermoformed	140	\$43.50	\$42.00	25	9MPMGT	9.0	5.9	1.18 gal	271.9
TWT96T	9.00 Terra-Cotta, Thermoformed	140	\$57.50	\$56.00	25	9MPMGT	9.0	5.9	1.18 gal	271.9
TWT96G	9.00 Green, Thermoformed	140	\$57.50	\$56.00	25	9MPMGT	9.0	5.9	1.18 gal	271.9
HP 10M	10" Black Haviland, Thermoformed	145	\$71.00	\$69.00	40	HP-10M	10.75	7.85	2.25 gal	520
HP 10MTC	10" Terra-Cotta Haviland, Thermoformed	145	\$95.50	\$93.00	40	HP-10M	10.75	7.85	2.25 gal	520

Pots & Containers

White Plastic Labels



Item #	Description	1-9	10+
PPL045	4-1/2" x 1" (1,000/roll – perforated)	\$20.60	\$19.50
PPL07	7" x 5/8" loop tag (1,000/roll – perf)	\$32.00	\$30.75

Item #	Description	1-7	8+
PPL04	4" x 5/8" (1,000/box – loose)	\$27.50	\$26.25
PPL05	5" x 5/8" (1,000/box – loose)	\$31.10	\$29.85

White Plastic T-signs



Item #	Description	Price
PPLAT10	3" x 5" Angled T-sign, 10 3/4" height, 50/cs	\$32.00
PPLAT16	2-1/2" x 4" Angled T-sign, 16" height, 50/cs	\$34.00
PPLAT21	4" x 6 1/4" Angled T-sign, 20 1/4" height, 25/cs	\$36.00
PPLATB	Base, fits all angled T-signs, 25/cs	\$48.50
PPL10	2 1/4" x 3 3/4" Flat T-sign, 10" height, 100/cs	\$39.00

Gro-Pot – Woven Planter Bag

Made with green 4.13 oz./Sq. Yd. UV stabilized woven cloth. Each pot has 2 sewn handles. Sold in packs of 25 pcs or bales of 100 pcs.



Item #	Description	25/Pack	100/Pack
WP09	9 Gallon	\$58.00	\$220.00
WP12	12 Gallon	\$62.00	\$235.00
WP15	15 Gallon	\$70.00	\$265.00

Wooden Baskets

Soft (woven) bottom. Great for pot covers for mums, etc. Half bushel and bushel basket have two wire handles.



Item #	Description	1-49	50+
BSB25	1 Peck, 11" Diameter x 7" Tall	\$4.70	\$4.35
BSB50H	1/2 Bushel, 14" Diameter x 9" Tall	\$5.30	\$4.90
BSB99H	Bushel, 18" Diameter x 11.5" Tall	\$6.05	\$5.60

Permanent Markers

Garden Marker: Fast drying, waterproof pen that contain filters for maximum fade resistance. Alcohol-based ink. Xylene free.
 Sharpie® Marker: Fine point permanent marker.



Item #	Description	Price	Quantity	Price
GGA3	Black Garden Marker	\$2.10	25+	\$1.90
GGA3000	Black Sharpie Marker	\$1.30	12+	\$1.20

Liquid Chalk

Use with T-signs. Will not wash off from rain or general watering but it can be removed with a moist paper towel. Older writing (ghosting) can be cleaned with an alcohol based hand sanitizer.



Item #	Description	Price
GGA30	Liquid Chalk Markers, 3pk-Red, Green, Blue	\$17.50

Nursery Containers, Thermoformed

TWTT1Q  TWTT1  TWTT1 now stocking other colors. Call for prices and availability.



Flexible sidewall with rim design that has good hoop strength.							Dimensions		Volume		Compatible Trays
Item #	Description	Pcs/Cs	1-5 Cs	6+ Cs	Skid Qty	Mfg Code	Dia.	Depth	Liquid	Cu. In.	
TWTT1Q	True Quart, 4.75" Black	600	\$76.00	\$74.00	24	TQTMGT	4.75	5.27	1.02 qt	59.10	SRT1Q-8
TWTT1	Trade Gallon, 6.5" Black	200	\$30.00	\$29.00	48	65NTGT	6.50	6.50	2.50 qt	144.00	SRTT1
TWTT2	Trade 2 Gallon, 8.5" Black	100	\$34.50	\$33.00	24	85NT2G	8.50	9.00	1.50 gal	346.20	
HP 100	True Gallon, 8" Black	170	\$47.50	\$46.00	70	HP-100	8.00	6.87	1.00 gal	231.00	NCCS1
HP 175	Trade 2 Gallon, 9" Black	150	\$61.50	\$60.00	54	HP-175	9.00	8.50	1.50 gal	346.00	
HP 200	True 2 Gallon, 9.75" Black	140	\$57.50	\$56.00	46	HP-200	9.75	9.12	2.00 gal	462.00	
HP 300	True 3 Gallon, 11" Black	120	\$71.00	\$69.00	36	HP-300	11.00	9.69	3.00 gal	693.00	
HP 500	True 4 Gallon, 12.2" Black	55	\$72.00	\$70.00	48	HP-500	12.22	11.63	4.02 gal	924.00	

Nursery Containers, Injection Molded



Heavy Duty, Rigid			Price Per Case				Dimensions		Volume		Compatible Trays
Item #	Description	Pcs/Cs	1-5 Cs	6+ Cs	Skid Qty	Mfg Code	Dia.	Depth	Liquid	Cu. In.	
NCT1	Black 300 Trade Gallon	68	\$35.00	\$34.00	42	INCTGAL	6.13	6.87	2.64 qt	152.06	NCCT1
NC T1C	Terra-Cotta 300 Trade Gal	68	\$46.50	\$45.50	42	INCTGAL	6.13	6.87	2.64 qt	152.06	NCCT1
NC S1	Black 400 True Gallon	75	\$62.50	\$61.00	30	INCSGAL	7.15	7.00	1.01 gal	232.38	NCCS1
NC T2	Black 600 Trade 2 Gallon	65	\$78.00	\$76.00	29	INCT2GAL	8.04	8.50	1.47 gal	339.17	
NC T2C	Terra-Cotta 600 Trade 2 Gal	65	\$88.00	\$86.00	29	INCT2GAL	8.04	8.50	1.47 gal	339.17	
NC T3	Black 1000 Trade 3 Gallon	59	\$108.00	\$105.00	16	INCT3GAL	10.41	9.50	2.79 gal	644.41	

Nursery Container Transport Trays



Nursery Container Carrying Trays			Price Per Case				Dimensions			Compatible Pots
Item #	Description	Pcs/cs	1-5 Cs	6+ Cs	Skid Qty	Mfg Code	Length	Width	Depth	
SRT1Q8	4.75" True Quart, 8 Count	75	\$73.00	\$71.00	36	QTTWL8	19.50	10.00	5.30	TWTT1Q
SRT1Q	4.75" True Quart, 12 Count	60	\$96.50	\$94.00	24	QTWLL12	19.00	14.12	4.81	TWTT1Q
SRTT1	6.50" Trade Gallon, 6 Count	50	\$76.00	\$74.00	42	TGOF6	19.63	13.00	6.71	TWTT1
NCCT1	300 Trade Gallon, 6 Count	50	\$53.00	\$51.00	36	3QTCT	19.50	12.75	2.50	NC-T1

Nursery Containers, HPP Blow Molding



Black flexible pots with rounded top rim that has multiple handle grips.							Dimensions		Volume	
Item #	Description	Pcs/Cs	1-5 Cs	6+ Cs	Skid Qty	Mfg Code	Dia.	Depth	Liquid	Cu. In.
HPP05S	5 Gallon, 500 Squat Series	30	\$46.50	\$45.00	48		14.00	10.00	5.00 gal	1,155
HPP06	6 Gallon, 700 Series	30	\$46.50	\$45.00	48		14.00	11.50	6.08 gal	1,405
Item #	Pots below sold by the piece	1-99	100-Skid	Skid Qty+	Skid Qty		Dia.	Depth	Liquid	Cu. In.
HPP078S	7.82 Gallon, 700 SQUAT Series	\$3.00	\$2.65	\$2.45	640		16.00	11.00	7.82 gal	1,806
HPP10S	10-1/2 Gal, 1000 SQUAT Series	\$3.65	\$3.30	\$3.05	640		17.80	12.00	13.49 gal	2,423
HPP10	10-1/2 Gallon, 1000 Series	\$3.55	\$3.20	\$2.95	560		16.50	14.75	10.67 gal	2,465
HPP13	13-1/2 Gallon, 1500 Series	\$3.55	\$3.20	\$2.95	480		18.20	16.00	13.66 gal	3,155
HPP20	20 Gallon, 2000 Series	\$5.80	\$5.40	\$5.10	260		20.00	17.00	20.04 gal	4,629
HPP27	27-1/2 Gallon, 2500 Series	\$7.35	\$6.90	\$6.50	300		24.00	18.00	27.50 gal	6,353

Hanging Baskets



Call for full skid pricing.

Pots & Containers



Hanging Baskets, Landmark Plastics			Price per case			Dimensions		Volume		Compatible Hangers	
Item #	Description Saucerless = Inside Saucer	Pcs/Cs	1-5 Cs	6+ Cs	Skid Qty	Mfg Code	Dia.	Depth	Liquid Gal.		Cu. In.
SHB710	White 10" Imperial Deco, Saucerless	50	\$39.50	\$38.00	50	IIBH10	10	6.5	1.5	346.5	SHBE10, E10L, W10
SHB710G	Green 10" Imperial Deco, Saucerless	50	\$39.50	\$38.00	50	IIBH10	10	6.5	1.5	346.5	SHBE10G, LG, W10
SHB710CB	Choc. Brown 10" Imperial, Saucerless	50	\$40.50	\$39.00	50	IIBH10	10	6.5	1.5	346.5	SHBE10LCB, W10
SHB210	White 10" Contempo Swirl, Saucerless	50	\$42.50	\$41.00	50	ICT10	9.88	6	1.28	295.05	SHBE10, E10L, W10
SHB210G	Green 10" Contempo Swirl, Saucerless	50	\$42.50	\$41.00	50	ICT10	9.88	6	1.28	295.05	SHBE10G, LG, W10
SHB311	White 11" Traditional, Saucerless	50	\$66.00	\$64.50	40	ICHB11	11	7	1.75	400	SHBE10L, W10
SHB311G	Green 11" Traditional, Saucerless	50	\$66.50	\$65.00	40	ICHB11	11	7	1.75	400	SHBE10LG, W10
NEW MOLD! Same volume and traditional design as HC Companies HTS11000, but even heavier built and in-rim hanger design.											
SHB212	White 12" Deco Swirl, Saucerless	25	\$45.00	\$43.50	48	IDS12	11.81	7.22	2.25	520.23	SHBE12, SHBW12
SHB212G	Green 12" Deco Swirl, Saucerless	25	\$45.50	\$44.00	48	IDS12	11.81	7.22	2.25	520.23	SHBE12G, SHBW12
SHB212B	Black 12" Deco Swirl, Saucerless	25	\$45.50	\$44.00	48	IDS12	11.81	7.22	2.25	520.23	SHBE12B, SHBW12

Hangers, for above Baskets

Item #	Description	Pcs/Pk	Price		Mfg Code	Type	Compatible Baskets	
			Per Pack	Pcs/Cs				Per Case
SHBE10	White 16" Plastic, 3 Strand	25	\$8.85	450	\$154.00	I16ACL	Double Clip	SHB710,210,10,511
SHBE10G	Green 16" Plastic, 3 Strand	25	\$8.85	450	\$154.00	I16ACL	Double Clip	SHB710G,210G,511G
SHBE10L	White 19" Plastic, 3 Strand	25	\$11.00	450	\$192.50	I19ACT	Snap Clip	SHB710, 210, 10
SHBE10LG	Green 19" Plastic, 3 Strand	25	\$11.00	450	\$192.50	I19ACT	Snap Clip	SHB710G, 210G
SHBE10LCB	Choc. Brown 19" Plastic, 3 Strd	25	\$11.00	450	\$192.50	I19SPCL	Snap Clip	SHB710CB
SHBW10	21" Wire 3 strand, Galvanized	50	\$12.00	500	\$115.00	Z21LH50	Wrapped Wire	SHB710,210,10,511
SHBE12	White 22" Plastic, 4 Strand	25	\$7.70	500	\$148.00	K22ACL	Double Clip	SHB212
SHBE12G	Green 22" Plastic, 4 Strand	25	\$7.75	500	\$149.00	K22ACL	Double Clip	SHB212G
SHBE12B	Black 22" Plastic, 4 Strand	25	\$7.75	500	\$149.00	K22ACL	Double Clip	SHB212B
SHBW12	24" Wire 4 strand, Galvanized	50	\$14.85	250	\$71.00	Z24164STW	Wrapped Wire	SHB212

Jiffy-7® – Peat Pellets

This pellet with a soft pre-formed center is held together by fine netting, ensuring optimum air/water exchange, and is filled with high-quality substrate and then compressed to form a handy pellet. Just add water, and the pellet grows to up to seven times its size. Pellet diameter: 42mm.



Item #	Description	Quantity	1-5 Cases	6+ Cases
JIF7	Jiffy-7® Peat Pellets	1,000/box	\$67.00	\$65.00



Hanging Baskets, KOBA



6" through 12" include plastic hangers, 14" include wire.			Price per case			Hangers (Included)	Dimensions		Volume	
Item #	Description Saucerless = Inside Saucer	Pcs/Cs	1-5 Cs	6+ Cs	Skid Qty		Dia.	Depth	Liquid	Cu. In.
SHB4045	White 4.5" Traditional w/ Snap-on Saucer	216	\$158.00	\$154.00	18	12" 3 Strand	4.5	4.38	1.60 pt	46.93
SHB406	White 6" Traditional w/ Snap-on Saucer	160	\$144.00	\$140.00	18	12" 3 Strand	6.0	4.13	1.16 qt	68.59
SHB408	White 8" Fluted, Saucerless	84	\$85.00	\$83.00	50	17" 3 Strand	8.0	5.13	0.70 gal	162.4
SHB408G	Green 8" Fluted, Saucerless	84	\$86.00	\$84.00	50	17" 3 Strand	8.0	5.13	0.70 gal	162.4
SHB4105	White 10.5" Trench Tek	96	\$90.00	\$88.00	40	17" 3 Strand	10.5	6.00	1.25 gal	288.6
SHB4105C	Terra-cotta 10.5" Trench Tek	96	\$91.00	\$89.00	40	17" 3 Strand	10.5	6.00	1.25 gal	288.6
SHB411	White 11" Traditional, Trench Tek	50	\$50.50	\$49.00	32	19" 3 Strand	11	6.38	1.73 gal	400.2
SHB411G	Green 11" Traditional, Trench Tek	50	\$51.00	\$49.50	32	19" 3 Strand	11	6.38	1.73 gal	400.2
SHB411B	Black 11" Traditional, Trench Tek	50	\$51.00	\$49.50	32	19" 3 Strand	11	6.38	1.73 gal	400.2
Trench Tek Hanging Baskets. Base design eliminates need for inside saucer resulting in less labor and cost.										
SHB412	White 12" Curved, Saucerless	50	\$105.50	\$103.00	24	22" 4 Strand	12.0	7.25	2.37 gal	548.7
SHB412C	Terra-cotta 12" Curved, Saucerless	50	\$106.50	\$104.00	24	22" 4 Strand	12.0	7.25	2.37 gal	548.7
SHB412G	Green 12" Curved, Saucerless	50	\$106.50	\$104.00	24	22" 4 Strand	12.0	7.25	2.37 gal	548.7
SHB414	White 14" Curved, Saucerless	60	\$185.50	\$181.00	27	26" 4 Str Wire	14.0	7.75	3.04 gal	703.7
SHB414C	Terra-cotta 14" Curved, Saucerless	60	\$187.50	\$183.00	27	26" 4 Str Wire	14.0	7.75	3.04 gal	703.7

Hanging Baskets, Belden Plastics



Wire hangers are included.						Wire Hangers (Included)	Dimensions		Volume	
Item #	Description Saucerless = Inside Saucer	Pcs Cs	1-5 Cs	6+ Cs	Skid Qty		Dia.	Depth	Liquid	Cu. In.
BHG10G	Green 10" Hanging Garden, Snap-on Saucer	25	\$138.00	\$134.50	40	21" 3 Strand	10	5.50	1.20 gal	277.2
SHB514	White 14" Traditional, Saucerless	25	\$168.00	\$165.00	30	26" 4 Strand	14	8.25	3.96 gal	914.7
SHB514C	Clay 14" Traditional, Saucerless	25	\$168.00	\$165.00	30	26" 4 Strand	14	8.25	3.96 gal	914.7

Jiffystrips®

These peat pots are 100% biodegradable and come in strips that fit in standard 1020 trays (see page 8) and can be torn into individual pots for easy planting.



Item #	Description	Pot Dia.	Pots/Strip	Pots/Case	1-5 Cases	6+ Cases
JIF525	#525 Strip only, fits 32ct in 1020 tray	2.50"	8	2304	\$134.00	\$131.00
JIF516	#516 Strip only, fits 50ct in 1020 tray	1.75"	10	5100	\$183.00	\$179.00
JIF519	#519 Strip only, fits 72ct in 1020 tray	1.50"	12	5040	\$259.00	\$254.00

Please contact us for pricing on full skid quantities. We also give additional discounts for large orders. Please call for detailed quote.





KHAN SATURN POTS, Round			Price per case			Mfg Code	Dimensions		Volume	
Item #	Description	Pcs/Cs	1-5 Cs	6+ Cs	Skid Qty		Dia.	Depth	Liquid	Cu. In.
DPS10	10" Terra-Cotta	50	\$55.00	\$53.00	40	KSAT10	11.48	7.86	2.05 gal	473.6
DPS12	12" Terra-Cotta	40	\$67.00	\$65.00	30	KSAT12	13.45	9.27	3.45 gal	797.3
DPS14	14" Terra-Cotta	30	\$87.50	\$85.00	16	KSAT14	15.87	11.19	5.76 gal	1330.6
DPF14	14" Fluted, Terra-Cotta	30	\$64.00	\$62.00	16	KFPN14	14.25	9.50	3.62 gal	836.6

HICKORY BARREL (Wood look), Round			Price per case			Mfg Code	Dimensions		Volume	
Item #	Description	Pcs/Cs	1-5 Cs	6+ Cs	Skid Qty		Dia.	Depth	Liquid	Cu. In.
DPH1050CB	10.5" Chocolate Brown	80	\$79.00	\$77.00	32	KCT270	10.50	7.50	1.83 gal	422
DPH13CB	13" Chocolate Brown	40	\$81.00	\$79.00	36	KCT340	13.00	9.60	3.5 gal	805
DPH1450CB	14.5" Chocolate Brown	30	\$82.00	\$80.00	36	KCT380	14.50	10.50	4.5 gal	1036

2 Piece SPARTA URN			Price per case			Mfg Code	Dimensions		Volume	
Item #	Description	Pcs/Cs	1-5 Cs	6-47 Cs	Skid Qty		Dia.	Depth	Liquid	Cu. In.
DPU12	12" White Urn	25	\$74.00	\$72.00	48	KCZ305	11.8	11.6	1.6 gal	374
DPU12BLK	12" Black Urn	25	\$56.00	\$54.00	48	KCZ305	11.8	11.6	1.6 gal	37

Botanica Series, Large Round			Price per case			Mfg Code	Dimensions		Volume	
Item #	Description	Pcs/Cs	1-5 Cs	6-17 Cs	Skid Qty		Dia.	Depth	Liquid	Cu. In.
DPV18T	17.75" Tan, Vineyard	15	\$98.00	\$95.00	18	KCFP18	17.75	13.75	8.10 gal	1,886
DPV18	17.75" Bronze, Vineyard	15	\$120.00	\$117.00	18	KCFP18	17.75	13.75	8.10 gal	1,886
DPP18	17.5" Bronze, Prestige	20	\$129.00	\$126.00	18	KCF018	17.50	14.25	7.85 gal	1,814



TREASURE BOWLS			Price per case			Mfg Code	Dimensions		Volume	
Item #	Description	Pcs/Cs	1-5 Cs	6+ Cs	Skid Qty		Dia.	Depth	Liquid	Cu. In.
DPTB12	12" Terra-Cotta	50	\$50.00	\$48.00	48	KTSB12	12	5.67	1.55 gal	359.1
DPTB12CB	12" Choc. Brown	50	\$50.00	\$48.00	48	KTSB12	12	5.67	1.55 gal	359.1
DPTB14	14" Terra-Cotta	50	\$78.00	\$76.00	36	KTSB14	14	5.75	2.09 gal	482.1

SERENE SQUARES			Price per case			Mfg Code	Dimensions		Volume	
Item #	Description	Pcs/Cs	1-5 Cs	6+ Cs	Skid Qty		Dia.	Depth	Liquid	Cu. In.
DPSQ075TA	7.50" Tan	100	\$82.00	\$80.00	60	KSMSQ75	7.50	7.25	1.11 gal	256.7
DPSQ11	11.50" Terra-Cotta	25	\$54.00	\$52.00	48	KSMQ115	11.50	10.00	3.50 gal	807.5

OVALS, Terra-Cotta			Price per case			Mfg Code	Dimensions		Volume	
Item #	Description	Pcs/Cs	1-5 Cs	6+ Cs	Skid Qty		Dia.	Depth	Liquid	Cu. In.
DPO12	12" Panterra, ITML	50	\$127.00	\$124.00	64	PAP1200	13x6.5	5.00	0.97 gal	223.0
DPO16	16" Khan Fluted	50	\$79.00	\$77.00	36	KOVL16	16x6.75	6.00	1.82 gal	419.5
DPO16S	Saucer for 16" Oval	50	\$40.00	\$39.00	72	KOVSL16	14.6x5.7	1.00	-	-

PLANTER BOX, Rectangular			Price per case			Mfg Code	Dimensions		Volume	
Item #	Description	Pcs/Cs	1-5 Cs	6-35 Cs	Skid Qty		Dia.	Depth	Liquid	Cu. In.
LPB714	7x14" Terra-Cotta	100	\$182.50	\$178.00	36	X714PB	7x14	4.19	1.36 gal	315.19

Decorative Planters



PAN080



CFB10



DPC16S
Or DPC25S



DP 12



DECK POTS, Round (Made in USA)			Price per case			Mfg Code	Dimensions		Volume	
Item #	Description	Pcs/Cs	1-5 Cs	6+ Cs	Skid Qty		Dia.	Depth	Liquid	Cu. In.
DP 08	8" Terra-cotta, Trench Tek	150	\$101.50	\$99.00	24cs, Also have bulk	KOBA	8.00	6.00	0.8 gal	184.79
DP 10	10" Terra-cotta, Trench Tek	70	\$78.00	\$76.00	32	KOBA	10.00	7.50	1.8 gal	425.9
DP 12	12" Terra-cotta	48	\$83.00	\$81.00	24	KOBA	12.00	9.00	3.5 gal	808.6
DP 14	14" Terra-cotta	20	\$62.50	\$61.00	27	KOBA	14.00	11.75	5.5 gal	1270.7

CURVE DECK POTS, Round (Made in USA)			Price per case			Mfg Code	Dimensions		Volume	
Item #	Description	Pcs/Unit	1-5	6+	Skid Qty		Dia.	Depth	Liquid	Cu. In.
DPC16S	16" Slate color	18/Cs	\$79.00	\$77.00	18	KOBA	16.00	12.2	6 gal	1418.8
DPC16HS	16" Honeysuckle color	600 Pcs	\$2180.00	Bulk Skid		KOBA	16.00	12.2	6 gal	1418.8
DPC20TC	20" Terra-cotta color	Per Pc	\$9.25	\$9.00	120 Pcs	KOBA	20.00	15.5	13.5 gal	3118.8
DPC20HS	20" Honeysuckle color	Per Pc	\$9.25	\$9.00	120 Pcs	KOBA	20.00	15.5	13.5 gal	3118.8
DPC25S	25" Slate color	Per Pc	\$18.25	\$17.75	100 Pcs	KOBA	25.00	18.5	21.37 gal	4938.1

Drain holes are not pre-punched on above 16, 20 & 25" pots.

Cut Flower Bucket

Solid base allowing for top-heavy blooms.			Price per case			Mfg Code	Dimensions		Volume	
Item #	Description	Pcs/Cs	1-5 Cs	6-39 Cs	Skid Qty		Dia.	Depth	Liquid	Cu. In.
CFB10	10" Black, no holes	30	\$42.50	\$41.50	40	KOBA	10.00	9	2.25 gal	519.8

Grow Pans Compatible hangers optimize greenhouse growing space.

Trench Tek bottom conserves water.			Price per case			Compatible Hangers	Dimensions		Volume	
Item #	Description	Pcs/Cs	1-5 Cs	6+ Cs	Skid Qty		Dia.	Depth	Liquid	Cu. In.
PAN080	8" Green Deko Pan	246	\$155.00	\$151.00	18	SHBE10G, LG, W10	8.00	4	0.525 gal	125
PAN100	10" Green Deko Pan	130	\$109.00	\$106.00	40	SHBE10G, LG, W10	10.00	4.5	1.05 gal	248
PAN120	12" Green Deko Pan	116	\$155.00	\$151.00	24	SHBE12G, SHBW12	12.00	5	1.56 gal	365

Corrugated Retail Flats Self-Locking. No stapling required! Same size as standard 1020 flats.

Item #	Description	Bundle/75pcs	Bundle/750pcs	Skid/1500pcs	Length	Width	Depth
CFC1020	Carry Out Tray	\$37.50 = 0.50 ea	\$330.00 = 0.44 ea	\$615.00 = 0.41 ea	21.25	10.50	2.50



True Series Inserts & Trays True 10"x20" size (These are NOT standard size)

For illustrations of pack layout see page 8						Mfg Code	Cell Dimensions			Pack Volume	
Item #	Description	Pcs/Cs	1-5 Cs	6-35 Cs	36 Cs		Length	Width	Depth	Liquid	Cu. In.
INT0804	T 804 Pack	100	\$52.50	\$51.00	Ask for pricing	T804	2.28	2.24	2.61	1.52 pt	44.00
INT0806	T 806 Pack	100	\$52.50	\$51.00		T806	2.28	1.50	2.61	1.42 pt	40.90
INT1204	T 1204 Pack	100	\$52.50	\$51.00		T1204	2.25	1.45	2.61	0.94 pt	27.16
INTJ0606	T 606 Super Jumbo Pack	100	\$55.50	\$54.00		T606SJ	2.21	2.03	3.25	1.14 qt	65.54
INTJ0804	T 804 Super Jumbo Pack	100	\$55.50	\$54.00		T804SJ	2.34	2.30	3.25	1.66 pt	47.99
INT1801	T 1801 Sheet of Pots	100	\$62.00	\$60.00		T1801SP	3.14	3.18	3.27	0.78 pt	22.58
CFT1	T Web Bottom Carrying Tray	100	\$65.50	\$64.00		ITIM	20.00	10.00	2.63		
CFTNCR	T NCR Tray, Solid, w/Drain holes	100	\$76.00	\$74.00	TNCRXD	20.00	10.00	2.71			

Market Packs & Handles

LMH & LMT6



Items on these pages, Call for full skid pricing.

3 of these fit per CFT1 tray (see above)						Cell Dimensions			Pack Volume		
Item #	Description	Pcs/Unit	1-5	6-31 Cs	Skid Qty	Mfg Code	Length	Width	Depth	Liquid	Cu. In.
LMT6	306 Pack, T Pot 6 Count	300/Cs	\$86.50	\$84.00	32	TPP6	10.11	6.73	3.5	0.72 pt	20.75
LMH	19" White Handle	100/Pk	\$34.00	\$33.00	20/Cs	DN1481	19	1	-	-	-

Call for full skid pricing.

HBB14C (basket)
HBE22GC (hanger)



HBC14 (basket)
HBE22B (hanger)



HBB14F (basket)
HBE22GC (hanger)



HBW14C (basket)



HBB14C (basket)
HBWCS (stand)



HBR14GC (basket)



HBR14BC (basket)
HBE22GC (hanger)

Multi-Formes Baskets

Coco Fiber Nest Baskets, Black Wire			Price per case					
Item #	Description	Pcs/Cs	1-5 Cs	6+ Cs	Skid Qty	Mfg Code	Depth	Volume
HBC12	12" Coco Fiber Nest Basket	12	\$100.00	\$97.50	36	400-J12CO	6.5"	2.13 gal
HBC14	14" Coco Fiber Nest Basket	12	\$109.50	\$107.00	45	400-J14CO	7.0"	3.13 gal
HBC16	16" Coco Fiber Nest Basket	12	\$129.00	\$126.00	30	400-J16CO	7.0"	4.25 gal
Black Wire Hangers for all above Baskets								
HBE22B	22" 3 Strand, Open Hook Hanger	12	\$32.80	\$32.00	30	400-HK22PN		
Pre-formed Replacement Coco Nest Liners								
HBC12L	12" Coco Replacement Liner	12	\$26.00	\$24.00	30	401-L12		
HBC14L	14" Coco Replacement Liner	12	\$34.00	\$32.00	30	401-L14		
HBC16L	16" Coco Replacement Liner	12	\$38.00	\$36.00	30	401-L16		
Decorative Baskets, Natural Bark and Wicker with Plastic Liner								
Item #	Description	Pcs/Cs	1-5 Cs	6+ Cs	Skid Qty	Mfg Code	Depth	Volume
HBB14F	14" Flat Bark Basket	12	\$102.00	\$99.00	24	750-61	6.0"	2.00 gal
HBB14C	14" Cone Bark Basket	12	\$104.00	\$101.00	24	750-62	15.0"	2.25 gal
HBW14C	14" Cone Wicker & Rice Basket	12	\$95.00	\$92.00	24	750-12	15.0"	2.25 gal
HBR14GC	14" Cone Green Rope & Twig Basket	12	\$105.00	\$102.00	24	750-36	15.0"	2.25 gal
HBR14BC	14" Cone Black & Tan Rope Basket	12	\$115.00	\$112.00	24	750-70	15.0"	2.25 gal
HBWCS	Wire stand for Cone Baskets	30	\$74.00	\$72.00	12	780-VAL	-	-
Galvanized Hangers for all above Baskets								
HBE22G	22" 3 Strand, Galvanized WIRE Hanger	12	\$13.00	\$12.50	24	400-HK22		
HBE22GC	22" 3 Strand, Galvanized CHAIN Hanger	12	\$37.00	\$36.00	24	400-CH22		



Water Breakers

High quality Dramm® water breakers are made from impact resistant ABS plastic with a stainless steel face plate.



Item #	Description	Spray Pattern	Price
WW 1000	RedHead	Soft, High Flow, Medium Pattern	\$11.00
WW 1000W	OrangeHead	Soft, High Flow, Wide Pattern	\$11.00
WW 750	LemonHead	Soft, Medium Flow	\$11.00
WW 400	Blue	Full Flow for drenching	\$6.50
WW 480	Small Red	Low Flow for drenching	\$6.50

Dramm® Handi-Reach Handles

Standard garden hose connections.



Item #	Description	Price
GGA16	16" Handi-Reach Handle, 45° angle	\$8.25
GGA24	24" Handi-Reach Handle, 45° angle	\$9.00
GGA36	36" Handi-Reach Handle, 45° angle	\$10.50
GGA48	48" Handi-Reach Handle, 45° angle	\$11.75
GGA360	36" w/90° angle for hanging baskets	\$10.90

Wonder Waterer



This high quality watering wand comes complete with filter and shutoff. The laser-cut faceplate creates a very uniform soft water pattern. It comes highly recommended by our plug growers.

Item #	Description	Price	8+
WW 3	Wonder Waterer	\$30.60	\$29.00
WW 31	Replacement Face Plate	\$6.35	\$6.05
WW 32	Replacement Filter Screen	\$4.00	\$3.60
WW 34	Filter Case with Screen	\$6.85	\$6.50

FOGG-IT Nozzle

These fine volume misting nozzle are a great aid in watering cuttings, delicate stock and hand misting. All bronze.



Item #	Description	Price	6+
GGA292	FOGG-IT nozzle, 1 gpm	\$9.60	\$9.10
GGA2922	FOGG-IT nozzle, 2 gpm	\$9.60	\$9.10

Dramm® Revolver Spray Gun

This heavy-duty spray nozzle has nine spray patterns which can easily be changed with the quick-click pattern changing. Ergonomic insulated grip.



Item #	Description	Price
GGA250	Dramm® Revolver	\$11.00

Dramm® ColorStorm™ Hose

Dramm ColorStorm-Professional Rubber Hose is made from EPDM rubber for a "crackless" hose cover that is resistant to abrasion and weathering. Heavy, hex shape that resists kinking.



Pre-assembled, with crimped nickel-plated ends:

Item #	Description	Price
DGH007050	ColorStorm Hose 3/4" x 50'	\$102.00
DGH007075	ColorStorm Hose 3/4" x 75'	\$140.00
DGH007100	ColorStorm Hose 3/4" x 100'	\$155.00
DGH006050	ColorStorm Hose 5/8" x 50'	\$65.00
DGH006075	ColorStorm Hose 5/8" x 75'	\$109.00
DGH006100	ColorStorm Hose 5/8" x 100'	\$115.00

Bulk Hose (We cut to any length):

Item #	Description	Per Foot	330' Bulk Roll
DGH007B	3/4" Yellow ColorStorm Hose	\$1.42	\$406.00

DGH7F	3/4" Female Crimped Hose End	\$9.00
DGH7M	3/4" Male Crimped Hose End	\$7.50
DGH6F	5/8" Female Crimped Hose End	\$6.00
DGH6M	5/8" Male Crimped Hose End	\$5.70

If you purchase hose, we'll install these hose ends at no charge.

Orbit® Fan Spray Nozzle

This fan nozzle features high quality plastic construction. The flow can easily be adjusted with the shut-off valve.



Item #	Description	Price
GGA320	Orbit® Fan Nozzle with Shut-off	\$4.50

Insulated Pistol Grip Nozzle

This Gilmour® nozzle has an insulated molded grip. Heavy-duty zinc body, male hose threaded front.



Item #	Description	Price
GGA310	Gilmour® Pistol Grip Nozzle	\$6.50

Dramm® OneTouch Valve

Flows 16 gpm @ 40 psi. Fingertip control with garden hose connections, FHT x MHT.



Item #	Description	Price
GHF779	Dramm® OneTouch High Flow Valve	\$14.50

Dramm® Lever Activated Valve

Full flow (up to 11 gpm) squeeze valve with garden hose connections, FHT x MHT.



Item #	Description	Price
GHF777	Dramm® Lever Activated Valve	\$12.75

Dramm® Syphonject

Fertilize while you water. Garden hose connection. Average rate is 20:1. Requires 35 psi at faucet and 3-5 gpm flow.



Item #	Description	Price
GGA200	Dramm® Syphonject™ Siphon Mixer	\$14.20



Garden Hose Shut-offs

All standard garden hose connections, FHT x MHT.



Item #	Description	Price
GHF771	Long Handle Plastic Shutoff	\$1.85
GHF77	Short Handle Plastic Shutoff	\$2.60
GHF772	Dramm® QAV Plastic Shutoff, High Flow	\$4.75
BBV0075	Dramm® Brass Shutoff	\$18.50
BBV0075A	Dramm® Aluminum Shutoff	\$17.70

Garden Hose Wye

Standard, FHT x MHT, with shut-offs on both outlets.



Item #	Description	Price
GHF770	Plastic Wye	\$2.50
BBV0077	Brass Wye	\$7.60

Garden Hose Ends & Couplers

Brass fittings include zinc clamp.
Plastic fittings include plastic clamp.



Item #	Description	Price
BGH7F	HD Brass, 5/8"- 3/4" Female	\$5.00
BGH7M	HD Brass, 5/8"- 3/4" Male	\$4.50
BGH7C	HD Brass, 5/8"- 3/4" Mender	\$6.75

Plastic Ends:

GHF07	Plastic, 5/8"- 3/4" Female	\$1.30
GHF17	Plastic, 5/8"- 3/4" Male	\$1.25
GHF27	Plastic, 5/8"- 3/4" Coupler	\$1.40
GHF05	Plastic, 1/2"-5/8" Female	\$1.35
GHF15	Plastic, 1/2"-5/8" Male	\$1.30
GHF25	Plastic, 1/2"-5/8" Mender	\$1.25

Brass Hose Ends

Connect to any hose. Clamps not included.



Item #	Description	Price
BGH005	1/2" Insert, Set = both FHT & MHT	\$6.75
BGH006	5/8" Insert, Set = both FHT & MHT	\$6.75
BGH007	3/4" Insert, Set = both FHT & MHT	\$6.75
BGH010F	1" Insert x Female Hose End	\$5.50
BGH010M	1" Insert x Male Hose End	\$4.50

Garden Hose Quick Couplers

These handy quick couplers are designed without a valve for maximum flow and allow water flow when disconnected.



Item #	Description	Price
BGH95	Brass Female Quick Coupler	\$5.00
BGH97	Brass Male Quick Coupler	\$2.50

Garden Hose Washers & End Cap



Item #	Description	Price
GHF12	Black Hose Washers (Pack of 12)	\$1.15
GHF12R	HD Red Hose Washers (Bag of 10)	\$1.15
GHF7	Garden Hose End Cap, FHT	\$0.38

Dramm® Brass Hose Swivel

Live swivel, works under pressure. Reduces kinks and twists in the hose.



Item #	Description	Price
BGHSV	Dramm® Live Hose Swivel	\$12.50

Garden Hose PVC Adapters



Item #	Description	Price
GHF37	MHT x 3/4" Soc (1" Spig)	\$1.30
GHF47	FHT x 3/4" Soc (1" Spig)	\$3.30
GHF57	MHT x 1/2" Soc (3/4" Spig)	\$1.30
GHF67	FHT x 1/2" Soc (3/4" Spig)	\$3.30

Garden Hose Adapters



Item #	Description	Price
BGH1624	Brass MHT x 3/4" MPT (1/2" FPT)	\$2.75
BGH1625	Brass MHT x MHT (1/2" FPT)	\$2.75
BGH1629	Brass FHT swivel x 1/2" MPT	\$4.90
BGH1635	Brass FHT swivel x 3/4" FPT	\$3.55
BGH1632	Brass FHT x FHT swivel	\$3.55
GHF87	Plastic FHT swivel x 3/4" MPT	\$3.30

Thermometers

Wall mount.
Nolt's logo on
GGA15 & GGA12.

GGA15HL shows
max and minimum
temperatures.

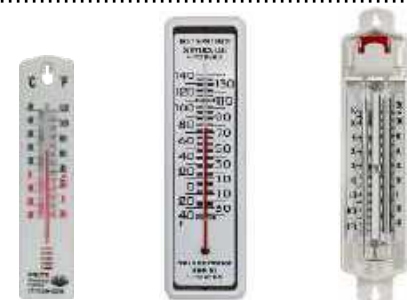

Item #	Description	Price
GGA15	7.5" Thermometer, Plastic Casing	\$3.00
GGA12	11.5" Thermometer, Aluminum Casing	\$16.00
GGA15HL	10.5" Max/Min Mercury Thermometer Plastic Casing, Magnet reset	\$31.00

Rain Gauge

Plastic casing, 6" capacity. Nolt's logo.



Item #	Description	Price
GGA20	Plastic Rain Gauge	\$6.00

Flower Pouches

Green plastic with loop handle.
Growing in flower pouch utilizes wall space and adds appeal. 250 per case.

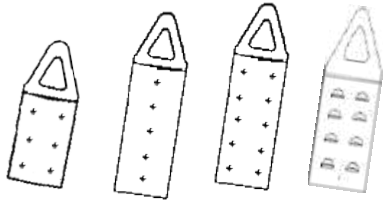

AFP05 AFP15 AFP1 GFP08



Item #	Description	Size	Volume	1-249	250+
AFP05	6 Slit, Al's Mini	8.5 x 13.5"	1.06 gal.	\$0.69	\$0.64
AFP15	5 Slit, Al's	8.5 x 21.25"	1.59 gal.	\$0.70	\$0.65
AFP1	10 Slit, Al's	8.5 x 21.25"	1.59 gal.	\$0.70	\$0.65
GFP08	8 Slit, Generation 2	8 x 20"	1.06 gal.	\$0.69	\$0.64

Insect Monitoring Cards

Durable, long-lasting pest monitoring and trapping cards are designed to catch a variety of pests.



Item #	Description	Price
PT 24	3" x 5" Yellow Sticky Traps, 48/pack	\$29.00

KleenGrow Disinfectant

Disinfectant & Algicide a biodegradable liquid concentrate for horticultural use that controls fungal, bacterial, viral plant pathogens and algae.



Corrosive
No UPS shipping!

Item #	Description	Price	Case/2
KG025	Pace Kleengrow, 2.5 gallon	\$205.00	\$200.00/ea.

Electrical Tape

PVC. Suitable for use below 600V and below 176°F.



Item #	Description	Price	10+
TAP007	Electrical Tape, 3/4" x 60', 7 mil	\$1.10	\$0.95

Latex Disposable Gloves

Textured, rubber latex disposable gloves. Food grade. Non-medical use only.



Item #	Description	Qty	Price
SAF5M	Medium Latex Gloves	100/box	\$8.00
SAF5L	Large Latex Gloves	100/box	\$8.00
SAF5XL	Extra Large Latex Gloves	100/box	\$8.00

HD Nitrile Disposable Gloves

See page 25 for black PVC gloves.

Blue industrial gloves w/diamond texture. Non-medical use only.

Item #	Description	Qty	Price
SAF6M	Medium HD Nitrile Gloves	100/box	\$15.80
SAF6L	Large HD Nitrile Gloves	100/box	\$15.80
SAF6XL	Extra Large HD Nitrile Gloves	100/box	\$15.80

Agritape Heat Mat Systems



An Agritape system consists of a control unit to regulate soil temperature, the Agritape Heat Mat, and a grounding screen. The screen serves to safely ground the current if the tape is damaged.

To install a system, roll out the Heat Mat and plug it into the control unit. Cover the Heat Mat with the ground screen. Connect the ground wire from the control unit to the screen. Plug in the control unit and place the sensor in the soil of the seed tray or container. Set to the desired soil temperature. Agritape will warm soil temperature by a maximum of 20°F (more with a humidity dome) above room temperature.



Does not work with GFCI outlets.

Electric current flows through black bars (which are a resistive/conductive material) to create a virtually continuous heat pattern.

Control Units: (Multi-outlet power strips can be used to add mats to a controller, however, do not exceed amp rating or max amount of tape.)

Item #	Description	Price
AT 220	Digital Control, 1 outlet, digital thermostat. Max: 50 sq. ft. of heat mats. Rated 8.5 amps.	\$75.00
AT 20	AT-JR Control, 2 outlets, dial thermostat. Max: 80 sq. ft. of heat mats. Rated 13 amps.	\$130.00
AT 21	AT-1 Control, 4 outlets, dial thermostat. Max: 120 sq. ft. of heat mats. Rated 20 amps.	\$142.00

Heat Mats, Stock sizes: (Grounding screen included)

Item #	Description	Price
AT 04	11" x 4' Agritape Heat Mat	\$41.00
AT 10	11" x 10' Agritape Heat Mat	\$71.00
AT 2210	22" x 10' Agritape Heat Mat	\$122.00
AT 4408	44" x 8' Agritape Heat Mat	\$169.00

Heat Mats, NON-STOCK: (Ships UPS from Rochester, NY. Allow 1-2 weeks for delivery. Shipping charge is additional to listed price.)

Item #	Description	Price
AT 3	11" Agritape - Custom Length (4-9 ft.)	\$8.75/ft.
AT 4	11" Agritape - Custom Length (10-25 ft.)	\$7.50/ft.
AT 5	Grounding Screen (for custom mats) 1-6 ft. wide, any length.	\$1.30 per sq. Ft.
AT 2204	22" x 4' Agritape Heat Mat	\$70.00
AT 2208	22" x 8' Agritape Heat Mat	\$102.00
AT 4404	44" x 4' Agritape Heat Mat	\$123.00

Humidity Domes

Clear plastic propagation domes. Fits standard 1020 size trays (see page 8).



HDT1020

Item #	Description	Each	50/Cs
HD 1020	Standard Domes, 21 1/4" x 11" x 2 1/2"	\$1.60	\$64.00
		1-39	40/Cs
HDT1020	Tall Domes, 21.25" x 11" x 7"	\$3.50	\$116.00





Nutriculture Water-Soluble Fertilizers

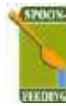

Plant Marvel fertilizers, manufactured by Plant Marvel Laboratories, are all water soluble and include both major and minor elements. Specific label with instructions on bag. **Call for pallet quantity pricing (88+ bags).**

General Purpose 20-10-20

A general purpose feed for greenhouse and nursery stock.

Item #	Description	Price	10+
PMF201020	Plant Marvel 20-10-20, 25 lb. Bag	\$37.50	\$36.00

General Purpose 20-20-20

A general purpose feed for greenhouse and nursery stock.

Item #	Description	Price	10+
PMF320	Plant Marvel 20-20-20, 25 lb. bag	\$36.50	\$35.00

General Purpose/Alkaline Water 20-7-20

Similar to 20-10-20, but can neutralize 1.5 times as many bicarbonates, making this ideal for growers with high alkalinity.

Item #	Description	Price	10+
PMF20720	Plant Marvel 20-7-20, 25 lb. Bag	\$38.00	\$36.50

Hydroponic Special 3-15-26

Contains all the elements to provide a basic diet for hydroponics.

Item #	Description	Price	10+
PMF31526	Hydroponic Special, 25 lb. bag	\$37.50	\$36.00

Other Brands of Fertilizers

Miller 10% Iron Chelate DP



A water soluble, totally chelated iron. Derived from: Iron DTPA.

Item #	Description	Price	10+
MIL93	Miller 10% Iron Chelate, 5 lb. bag	\$59.00	\$57.50

Caliber-Cote® Controlled Release Fertilizer

Nursery Fertilizer. Incorporate in soil or top dress. 50 lb. bag.

Item #	Description	Price	5+
HCC314	Caliber-Cote® 14-14-14, 3-4 month	\$71.00	\$69.00
HCC18612	Caliber-Cote® 18-6-12, 3-4 month	\$64.00	\$62.00
HCC186126	Caliber-Cote® 18-6-12, 5-6 month	\$68.00	\$66.00

Epsom Salt (Magnesium Sulfate)

A water soluble magnesium and sulphur mix.

Skid = 54 bags
Call for pricing.

Item #	Description	Price	10+
ES 50	Epsom Salt, 50 lb. bag	\$20.00	\$18.50

Potassium Nitrate 13.7-0-46

Yara Krista™ K Soluble Potassium Nitrate.

Oxidizer
No UPS shipping!

Item #	Description	Price	10+
PN 50	Potassium Nitrate, 50 Lb. Bag	\$51.25	\$49.00

Mum Finisher K-Mag 15-5-30

NEW FOR
2025

High nitrate nitrogen content. Ideal feed to overcome nitrogen and potash deficiencies in mature pot mums. Promotes improved resistance to fungus diseases and increases fibrous content.

Item #	Description	Price	10+
PMF15530	Mum Finisher, 25 lb. Bag	\$37.50	\$36.00

Hi-Cal Special 15-0-15 + 10.5% Calcium

This plug growing formula with high nitrate nitrogen, calcium, magnesium, and minor elements.

Item #	Description	Price	10+
PMF15015	Hi-Cal Special, 25 lb. Bag	\$33.50	\$32.00

Mag-Iron Special 18-6-18

A high magnesium and iron combination formulated for growers with high calcium bicarbonate water. The higher iron levels are provided in two different chelated forms, EDTA and DTPA.

Item #	Description	Price	10+
PMF18618	Mag-Iron Special, 25 lb. bag	\$37.50	\$36.00

Cal-Mag Special 17-5-17

Has 4% Calcium, 1% Magnesium and all the major and minor nutrients in a highly soluble form. High Nitrate to ammonia ratio.

Item #	Description	Price	10+
PMF17517	Cal-Mag Special, 25 lb. Bag	\$37.00	\$35.50

Cal-Mag Special 16-3-16

Has 4% Calcium, 2% Magnesium. Alternative to 17-5-17 to give greater control over vegetative growth and keep blooms longer.

Item #	Description	Price	10+
PMF16316	Cal-Mag Special, 25 lb. Bag	\$36.50	\$35.00

Calcium Nitrate, 15.5-0-0 + 19% Calcium (Greenhouse Grade)

Skid = 49 bags, call for pricing.

White, granular, water soluble fertilizer. Not for foliar feeding.

Item #	Description	Price	10+
CN G50	Calcium Nitrate, 15.5-0-0, 50 lb. Bag	\$30.50	\$29.00

Sulfuric Acid

Sulfuric Acid 66° BE, 93% tech grade. Used to treat high alkalinity water to keep soil PH from rising.

Corrosive
No UPS shipping!

Item #	Description	Price	4+
SUA1	Sulfuric Acid, 1 gallon	\$18.50	\$17.00

OBR Citric Acid

Lower pH the natural way. An Organic Bicarbonate Reducer that is derived from Citric Acid and used to lower the pH of soil less media and water. It chelates micro nutrients that may otherwise be unavailable. Highly compatible with other soluble products.

Item #	Description	Price	10+
PMFOBR	Water soluble OBR, 25 lb Bag	\$87.50	\$85.00



Dramm® Mini AutoFog™

(See page 51 for Fogit greenhouse sprayers.)

The Dramm Mini AutoFog is an easy to use, low volume chemical applicator designed with smaller greenhouses in mind. It can treat 5,000 sq. ft. automatically without an operator present. It can easily apply a wide variety of chemical formulations using a highly concentrated spray solution. A specially designed nozzle generates billions of micro-particles (0.05 - 10.0 microns) that fill the entire treatment area with active chemical. These tiny particles ensure complete and even coverage of all plant surfaces. This "low-volume" method of applying chemical solutions eliminates costly run-off and reduces the amount of chemical needed. 24 Hour timer, starts and stops automatically. Durable oilless compressor for even supply of air. 60 rpm mechanical agitation—keeps chemicals in suspension.

Standard Treatment Area: Up to 5,000 sq. Ft. (7,000 sq ft with circulation fans)

Nozzle: Air atomizing, outputs 8 liters in 4 hours.

Adjustable Nozzle Height: 5-7 ft.

Tank size: 8 Liters (8.45 quarts)

Item #	Description	Price
DFA10SS	110 Volt Mini AutoFog™ with SS Nozzle	\$4480.00



Dramm® K-10 Portable PulsFOG®

The PulsFOG thermal fogger is perfect for the rapid application of greenhouse chemicals. Designed to expel chemicals at great distances and speed, reduces application time and ensures even coverage of all surfaces with a highly dense, visible fog.

Perfect for the application of insecticides, fungicides, and disinfectants.

Propels chemical: 45 ft with NutriFog, 100 ft with VK-1 (more with the help of circulation fans)

Output: 10 liters (2.6 gal) in 45 minutes.

Item #	Description	Price
DFP10	25 Hp 2.6 gallon Thermo Fogger	\$3,365.00



NutriFOG

For best results, the PulsFOG requires the use of carrier solution. It helps to create more even particle size, distribute the solution throughout the area, and retard evaporation of fog droplets. This carrier is a 10-3-3 Foliar Fertilizer. It can be used with all chemical formulations. It is safe on ornamentals, fruits & vegetables.

Do not use more than five times in one month on the same crop.

Rates for NutriFOG:

- 0.25 Quart NutriFOG Solution
- 1.75 Quarts Water
- Apply above mix into 10,000 square feet of area

Item #	Description	Price
DFPNF	NutriFog, 5 gallon pail	\$405.00

Hormex® Rooting Powder



Clone plants from cuttings; works in all growing mediums; for hydroponics, air layering and grafting; helps to prevent root rot in cuttings; allows proper oxygen levels; Hormogenized™ for consistent rooting and plant growth. **Rooting Powder #1:** For easy to root plants—tender houseplants and flowers such as Begonia, Mums, Coleus, Fuchsia, Geranium, Hydrangea, Raspberry, Herbs and more.

Rooting Powder #3: For moderately easy to root plants—such as Arbor-vitae, Azalea, Blueberry, Juniper, Ivy, Rose and more.

Rooting Powder #8: For moderately difficult to root plants—Boxwood, Grape, Holly, Lilac, Rhododendrons, and some trees.

For a more detailed list see hormex.com/rooting-powder-strength

Item #	Description	Price
RP0101	Rooting Powder #1 — 1 Lb.	\$37.00
RP0103	Rooting Powder #3 — 1 Lb.	\$53.00
RP0108	Rooting Powder #8 — 1 Lb.	\$68.00
RP03138	3 Pack #1,#3 and #8—3/4 oz. of each	\$28.00

Companion® Biological Fungicide

For Greenhouse, Nursery & Ornamental Crops

- For prevention and control of soil and foliar diseases.
- Produces a broad-spectrum antibiotic that disrupts the formation of pathogen cells. **Use via:** foliar, soil drench, hydroponics, soil less, constant feed, irrigation & mist systems.



Item #	Description	Price	Case/2
CBF025	Companion, 2-½ Gallon	\$310.00	\$297.00/ea.

Protizer® Seed & Plant Activator



Grow strong roots & reduce plant loss. Rich in kelp, humic acid, mycorrhizae fungi and billions of beneficial microbes. For foliar, dipping, or injection at 1:100 dissolve 1.25 - 1.50 lbs with 10 gallons water. 1.5 to 4 lbs per 1000 sq. ft. of table space. Lower rate during propagation. Higher rate for stressed plants.

Item #	Size	Price	Item #	Size	Price
PRO04	4 Lb. Container	\$107.00	PRO27	27 Lb. Pail	\$618.00

Moldex Halfmask Respirators

The Moldex 8000 Resposable™ is a low maintenance, affordable, reusable respirator. Comes pre-assembled with cartridges.



Item #	Description	Price
M8000	Moldex 8000 Halfmask Respirator	\$54.00
M8002	Pair of Prefilters	\$8.50
M8004	Pair of Replacement Cartridges	\$20.00



Chemilizer Proportional Injector, 11 GPM

The big advantage of this unit is that the chemical pump takes all the abuse of the chemicals and is easy to disassemble or replace by hand. Parts are inexpensive, too. The water powered motor is never contaminated by any chemicals and comes with a 2-year warranty. This proportional fertilizer injector automatically compensates for any change in water pressure or flow to provide a constant mix at 1:100 rate.

Max Temperature: 100° F Standard pump: fixed ratio 1:100.

Flow Rate: 1.2 – 660 gph (0.02 – 11 gpm) Operating Pressure: 3 – 85 psi.

Connections: 3/4" male hose thread.

Optional Adjustable pump: 1:50-1:164 add \$76.00 to unit cost.



Replacement parts in stock. We service in store.

Item #	Description	Price
CPI12	Chemilizer Unit (Model CH9000-210), 1:100	\$272.00
CPI1	Bypass for Chemilizer, FHT x MHT, this plumbing comes with three valves, filter, and check valve.	\$70.00
CPI120	Cart Unit: Includes Chemilizer, bypass, 6 gal. tank, and push cart.	\$470.00

Dosmatic SuperDos Proportional Injectors

SuperDos operates without electricity to precisely inject liquid concentrates into a water supply line using fluid flow as the power source. SuperDos is designed with a patented internal mixing chamber that promotes homogeneous mixing, while segregating harsh chemicals from critical internal components. These proportional fertilizer injectors automatically compensate for any change in water pressure or flow and provide a constant mix at the rate you set. Replacement parts in stock. We service in store.



Item #	Description	Injection Ratios	Flow Rates	Operating PSI	Price
DSD20	SuperDos 20, 1" MPT	1:40 – 1:500	0.05 – 20 gpm	5 – 100	\$485.00
DSD20Bypass	On/off handle for DSD20	–	–	–	\$48.00
DSD30	SuperDos 30, 1" MPT, On/off handle installed	1:40 – 1:500	0.15 – 30 gpm	5 – 100	\$610.00
DSD45	SuperDos 45, 1 1/4" MPT, On/off handle installed	1:40 – 1:500	0.50 – 45 gpm	5 – 100	\$875.00

MixRite Proportional Injector, 11 GPM

This fixed ratio 1:100 offers an alternative to the Chemilizer with similar specifications.

This proportional fertilizer injector automatically compensates for any change in water pressure or flow to provide a constant mix at 1:100 rate. Standard pump: fixed ratio 1:100. Flow Rate: 10.2 – 660 gph (0.17 – 11 gpm)

Operating Pressure: 6 – 120 psi. Connections: 3/4" male thread.

Also available upon request: 22 GPM, 45 GPM and 110 GPM units.

MixRite

Replacement parts in stock. We service in store.



Item #	Description	Price
MR11	MixRite Unit (Model 556AG), 1:100	\$265.00
DOS1	Bypass for MixRite, FHT x MHT, this plumbing comes with three valves, filter, and check valve.	\$65.00
MR110	Cart Unit: Includes MixRite, bypass, 6 gal. tank, and push cart.	\$460.00

Handheld pH & EC Meters

PH Meters: Easily measure pH and temperature of water.

EC Meters: Easily measure EC (electrical conductivity), TDS (total dissolved solids), and temperature of water. Often used to determine if an injector is working correctly.

Item #	Description	Price
PHM080	Economy pH meter, 0.2 pH accuracy,	\$39.50
PHM200	Professional pH meter, 0.02 pH accuracy, waterproof	\$79.50
PHMST	PH Meter Storage Solution, 2oz Bottle	\$8.50
PHMBS	7.0 PH Buffer Solution, 20ml packet	\$2.00
ECM080	Economy EC meter, +/- 2% accuracy	\$38.00
ECM100	Professional EC meter, +/- 2% accuracy, waterproof	\$64.00
ECMCS	EC Meter Calibration Solution, 20ml packet, 1000PPM	\$2.00



Dosatron® Proportional Injectors

Dosatron® has been serving the horticulture industry for over 35 years and has established itself as the industry standard. Durable and reliable, these units come with common wear parts included. These water powered proportional fertilizer injectors automatically compensate for any change in water pressure or flow and provide a constant mix at the rate you set. Ratio is easy to adjust by hand with lock to ensure your setting isn't changed accidentally. Ideal for fertilizers, fungicides, acids and more. Maximum Temperature: 104° F



Wear part replacement kits in stock.

Item #	Description	Injection Ratios	Flow Rates	Operating PSI	Price
DOS11	D25F1, 3/4" MPT (Our most precise 11 gpm unit)	Fixed 1:100	0.04 – 11 gpm	4.3 – 85	\$335.00
DOS110	Cart Unit: DOS11, bypass, 6 gal. tank, and push cart.	–	–	–	\$529.00
DOS14	Dosatron D14MZ2, 3/4" MPT	1:50 – 1:500	0.04 – 14 gpm	4.3 – 85	\$420.00
DOS140	Cart Unit: DOS14, bypass, 6 gal. tank, and push cart.	–	–	–	\$614.00
DOS1	Bypass assembly for DOS11 and DOS14; FHT x MHT includes three valves, filter, and check valve.	–	–	–	\$65.00
DOS20	Dosatron D45RE15, 1" MPT, On/off handle installed	1:66 – 1:500	0.4 – 20 gpm	7 – 70	\$548.00
DOS40	Dosatron D40MZ2, 1 1/2" MPT, On/off handle installed	1:50 – 1:500	2.2 – 40 gpm	2.2 – 116	\$895.00

Solo® Sprayers

Solo 425® features: Four gal. HDPE tank with ultra-violet protection. Large 4.25" opening for easy filling and cleaning. Chemically resistant Viton® seals insure long life and durability. With its connecting rod-activated piston pump, the 425® is capable of producing a wide pressure range of up to 90 psi.

Solo 430-2G® features: All Viton® seals, long hose, large pump handle and other useful features. Includes an assortment of four nozzles.

We stock some parts for these sprayers.

Item #	Description	Price
SOL425	Solo 425® Backpack Sprayer, 4 gal.	\$89.00
SOL430	Solo 430-2G® Knapsack Sprayer, 2 gal.	\$34.00



Battery Operated Sprayers

Spray Caddy: 2.2 GPM Remco pump set at 100 PSI. 15' Hose with deluxe hand wand & adjustable brass nozzle. Cart with 10" wheels. A convenient six gallon container that lifts out to fill and clean. 12V units includes 12V battery with fused switch and regulated charger that prevents overcharging. SUP5TB has a tool battery adapter with overload protection and it'll cut out when volts gets to low.

Portable Sprayers: Ideal to mount on a garden cart, ATV, etc. 12 Volt pump set at 100 PSI. 15' Hose with hand wand & adjustable brass nozzle. Includes wire harness with switch & fuse to connection to 12V battery (battery not included).

Item #	Description	Price
SUP5	Spray Caddy with 12V Battery and charger	\$345.00
SUP5TB	Spray Caddy with adapter to run on Dewalt or Milwaukee 20V battery, battery & charger not included	\$345.00
SUP15	Portable Sprayer, 15 gal. tank	\$195.00
SUP25	Portable Sprayer, 25 gal. tank	\$270.00



Black PVC Gloves

For chemical handling. Cotton Lined.



Item #	Description	Price/Pair	Bnd 12/Pair
SAF12	12" Black PVC Gloves	\$3.75	\$3.25 ea.

Safety Goggles



See page 23 for respirators.

Item #	Description	Price
SAF15	MSA Chemical Splash Guard Goggles	\$4.60

Insert Hose Fittings

Insert Tee

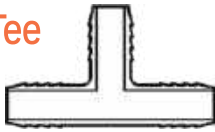

Item #	Size	Price
PIF1401005	½"	\$1.75
PIF1401007	¾"	\$1.75
PIF1401010	1"	\$2.20
PIF1401015	1½"	\$3.55
PIF1401020	2"	\$6.00

Insert Tee, Reducing



Item #	Size	Price
PIF1401101	¾ x ½"	\$2.20
PIF1401131	1 x ¾"	\$2.35
PIF1401210	1½ x ¾"	\$4.70
PIF1401211	1½ x 1"	\$4.70
PIF1401249	2 x 1"	\$6.00

Tee, Insert x FPT

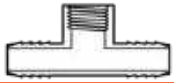

Item #	Size	Price
PIF1402005	½"	\$1.95
PIF1402007	¾"	\$2.60
PIF1402010	1"	\$3.00
PIF1402015	1½"	\$6.75
PIF1402020	2"	\$7.40

Tee, Insert x FPT, Reducing

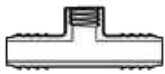

Item #	Size	Price
PIF1402101	¾ x ½"	\$2.20
PIF1402131	1 x ¾"	\$2.80
PIF1402210	1½ x ¾"	\$6.30
PIF1402211	1½ x 1"	\$6.30
PIF1402248	2 x ¾"	\$6.70
PIF1402249	2 x 1"	\$7.20

Tee, Insert x MPT

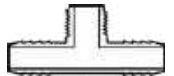

Item #	Size	Price
PIF1403005	½"	\$2.50
PIF1403007	¾"	\$3.05
PIF1403010	1"	\$3.80
PIF1403015	1½"	\$5.00
PIF1403020	2"	\$6.75

Insert Coupling



Item #	Size	Price
PIF1429005	½"	\$0.85
PIF1429007	¾"	\$0.90
PIF1429010	1"	\$0.92
PIF1429015	1½"	\$1.45
PIF1429020	2"	\$2.50

Insert Plug



Item #	Size	Price
PIF1449005	½"	\$1.40
PIF1449007	¾"	\$1.40
PIF1449010	1"	\$1.80
PIF1449015	1½"	\$2.30
PIF1449020	2"	\$3.75

90° Ell, Insert



Item #	Size	Price
PIF1406005	½"	\$1.65
PIF1406007	¾"	\$1.80
PIF1406010	1"	\$1.95
PIF1406015	1½"	\$2.30
PIF1406020	2"	\$3.00

90° Ell, Insert x FPT



Item #	Size	Price
PIF1407005	½"	\$1.85
PIF1407007	¾"	\$1.85
PIF1407010	1"	\$2.25
PIF1407015	1½"	\$3.50
PIF1407020	2"	\$5.25

90° Ell, Insert x MPT

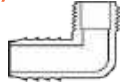

Item #	Size	Price
PIF1413005	½"	\$2.10
PIF1413007	¾"	\$2.60
PIF1413010	1"	\$3.30
PIF1413015	1½"	\$5.25
PIF1413020	2"	\$7.20

FPT x Insert Adapter

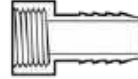

Item #	Size	Price
PIF1435005	½"	\$3.60
PIF1435007	¾"	\$3.60
PIF1435010	1"	\$3.85
PIF1435012	1¼"	\$4.75
PIF1435015	1½"	\$5.25
PIF1435020	2"	\$6.00

MPT x Insert Adapter

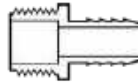

Item #	Size	Price
PIF1436005	½"	\$0.80
PIF1436007	¾"	\$0.90
PIF1436010	1"	\$0.90
PIF1436012	1¼"	\$1.45
PIF1436015	1½"	\$1.45
PIF1436020	2"	\$2.55

MPT x Insert Adapter, Reducing

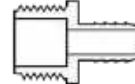

Item #	Size	Price
PIF1436074	½ x ¾"	\$2.35
PIF1436101	¾ x ½"	\$2.25
PIF1436102	¾ x 1"	\$2.35
PIF1436131	1 x ¾"	\$2.25
PIF1436133	1 x 1½"	\$3.70
PIF1436211	1½ x 1"	\$3.35
PIF1436213	1½ x 2"	\$4.70
PIF1436251	2 x 1½"	\$4.70

SCH80 Nipples, MPT x MPT



Item #	Size	Price
S8N882005	½" x Close	\$1.15
S8N882030	½" x 3"	\$1.20
S8N883005	¾" x Close	\$1.20
S8N883060	¾" x 6"	\$1.87
S8N884005	1" x Close	\$1.45
S8N884060	1" x 6"	\$2.26
S8N886005	1½" x Close	\$2.00
S8N887005	2" x Close	\$2.50

SS Hose Clamps

All stainless steel — won't rust.



Item #	Size	Ea.	Bag/10
SSC004	#4	\$0.70	\$6.50
SSC005	½"	\$0.83	\$7.80
SSC007	¾"	\$0.84	\$7.90
SSC010	1"	\$0.85	\$8.00
SSC015	1½"	\$0.86	\$8.10
SSC020	2"	\$0.87	\$8.20

PVC Unions



Item #	Size	Price
Threaded:		
U8F005	½" FPT	\$3.00
U8F007	¾" FPT	\$4.50
U8F010	1" FPT	\$4.80
U8F015	1½" FPT	\$9.25
U8F020	2" FPT	\$12.50
Socket:		
U8S005	½" SOC	\$2.75
U8S007	¾" SOC	\$3.25
U8S010	1" SOC	\$4.00

Clear Vinyl Tubing

Can be used for replacement suction hose on injectors.
15% Discount on 100' rolls.

Item #	Size	Max PSI	Price Per Ft.
CVT002	¼"	55	\$0.21
CVT003	¾"	45	\$0.28

Pressure Gauges

2" Face. ¼" MPT base.



Item #	PSI Range	Price
PG 030	0-30	\$4.00
PG 060	0-60	\$4.00
PG 100	0-100	\$4.00
PG 200	0-200	\$4.00

Schedule 40 Fittings

Socket Tee



Item #	Size	Price
SPF401005	1/2"	\$0.84
SPF401007	3/4"	\$0.86
SPF401010	1"	\$1.44

FPT Tee

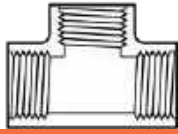

Item #	Size	Price
SPF405005	1/2"	\$3.10
SPF405007	3/4"	\$3.65
SPF405010	1"	\$4.45

Socket Ell

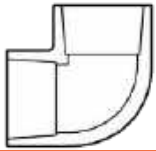

Item #	Size	Price
SPF406005	1/2"	\$0.68
SPF406007	3/4"	\$0.70
SPF406010	1"	\$1.05

Ell, Socket x FPT



Item #	Size	Price
SPF407005	1/2"	\$0.85
SPF407007	3/4"	\$0.85
SPF407010	1"	\$1.45

FPT Ell

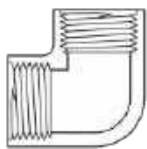

Item #	Size	Price
SPF408005	1/2"	\$1.70
SPF408007	3/4"	\$2.20
SPF408010	1"	\$4.10

Spig x FPT Adp.

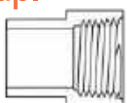

Item #	Size	Price
SPF478005	1/2"	\$0.85
SPF478007	3/4"	\$0.90
SPF478010	1"	\$1.25

Socket Coupling

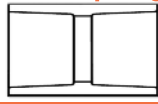

Item #	Size	Price
SPF429005	1/2"	\$0.46
SPF429007	3/4"	\$0.55
SPF429010	1"	\$0.85

FPT Coupling

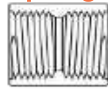

Item #	Size	Price
SPF430005	1/2"	\$0.85
SPF430007	3/4"	\$1.45
SPF430010	1"	\$1.70

FPT x Socket Adp.

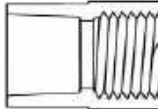

Item #	Size	Price
SPF435005	1/2"	\$0.75
SPF435007	3/4"	\$0.85
SPF435010	1"	\$0.90

MPT x Socket Adp.

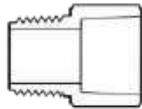

Item #	Size	Price
SPF436005	1/2"	\$0.60
SPF436007	3/4"	\$0.62
SPF436010	1"	\$0.95

MPT x Socket Adp., Reducing

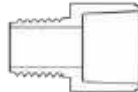

Item #	Size	Price
SPF436074	1/2 x 3/4"	\$1.20
SPF436101	3/4 x 1/2"	\$1.00
SPF436102	3/4 x 1"	\$1.55
SPF436131	1 x 3/4"	\$3.00

Spig x Insert Adp.

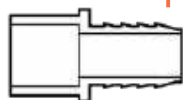

Item #	Size	Price
SPF460007	3/4"	\$2.80
SPF460010	1"	\$2.60

Bushing, Spig x Soc

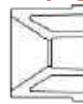

Item #	Size	Price
SPF437101	3/4 x 1/2"	\$0.65
SPF437130	1 x 1/2"	\$1.00
SPF437131	1 x 3/4"	\$1.00

Bushing, Spig x FPT

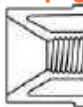

Item #	Size	Price
SPF438072	1/2 x 1/4"	\$1.50
SPF438098	3/4 x 1/4"	\$1.50
SPF438101	3/4 x 1/2"	\$1.00
SPF438130	1 x 1/2"	\$1.45
SPF438131	1 x 3/4"	\$1.45

Bushing, MPT x FPT

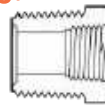

Item #	Size	Price
SPF439072	1/2 x 1/4"	\$3.20
SPF439098	3/4 x 1/4"	\$1.80
SPF439101	3/4 x 1/2"	\$1.80
SPF439130	1 x 1/2"	\$2.20
SPF439131	1 x 3/4"	\$2.20
SPF439168	1 1/4 x 1"	\$2.75
SPF439210	1 1/2 x 3/4"	\$3.30
SPF439211	1 1/2 x 1"	\$3.30
SPF439212	1 1/2 x 1 1/4"	\$3.30
SPF439248	2 x 3/4"	\$3.35
SPF439249	2 x 1"	\$3.35
SPF439251	2 x 1 1/2"	\$3.35

Socket Cap



Item #	Size	Price
SPF447005	1/2"	\$0.62
SPF447007	3/4"	\$0.65
SPF447010	1"	\$0.90

Compression Adapter

Assemble your own compression fittings. For Sch40 fittings.



Item #	Size	Price
OTFCA005	1/2" Spig	\$0.16
OTFCA007	3/4" Spig	\$0.32

Schedule 40 PVC Pipe



Item #	Size	Price/ft.
S40005	1/2"	\$0.70
S40007	3/4"	\$0.75
S40010	1"	\$1.05

PVC Pipe Cement

Lo-VOC, medium-bodied, clear cement for use on all schedules and classes of PVC pipe and fittings up to 6" diameter.



Item #	Size	Price
PVC	1/2 Pint	\$5.50

Teflon Thread Tape

PTFE tape, 3.5 mil thickness.



Item #	Size	Price
TAP005	1/2" x 520"	Ea. \$0.65 10+ \$0.60
TAP010	1" x 520"	Ea. \$1.05 10+ \$1.00

Ratchet PVC Pipe Cutter

Cuts up to 1" PVC pipe.



Item #	Description	Price
PVC45	PVC Cutter	\$18.00

Plastic Pipe & Poly Tubing Cutter

Cuts up to 1" pipe or tubing. Fast, clean cutting.



Item #	Description	Price
PTC	Tubing Cutter	\$11.50

Compression Cap



Item #	Size	Price
OTFCEC005	1/2"	\$0.82
OTFCEC007	3/4"	\$1.02

PVC Ball Valves



Item #	Size	Price
Threaded:		
BVF005	½" FPT	\$1.98
BVF007	¾" FPT	\$2.60
BVF010	1" FPT	\$3.95
BVF012	1¼" FPT	\$4.95
BVF015	1½" FPT	\$6.75
BVF020	2" FPT	\$9.10
Socket:		
BVS005	½" SOC	\$1.98
BVS007	¾" SOC	\$2.60
BVS010	1" SOC	\$3.95

PVC Union Ball Valves



Item #	Size	Price
BUS005	½" SOC	\$6.80
BUS007	¾" SOC	\$8.50
BUS010	1" SOC	\$11.50

Brass Ball Valves, FPT



Item #	Size	Price
BBV005	½" FPT	\$7.50
BBV007	¾" FPT	\$9.80
BBV010	1" FPT	\$14.90
BBV012	1¼" FPT	\$23.00
BBV015	1½" FPT	\$31.00
BBV020	2" FPT	\$42.00

Brass Ball Valves, Insert



Item #	Size	Price
BBVI007	¾"	\$22.50
BBVI010	1"	\$25.00
BBVI012	1¼"	\$42.00

Brass Swing Check Valve

Full flow, FPT x FPT



Item #	Size	Price
BSV005	½" FPT	\$9.00
BSV007	¾" FPT	\$9.50
BSV010	1" FPT	\$12.80
BSV012	1¼" FPT	\$18.00
BSV015	1½" FPT	\$23.50
BSV020	2" FPT	\$33.50

Brass Boiler Drain Valves

MPT inlet x Male Garden Hose Thread outlet.



Item #	Size	Price
BBD005	½" MPT Base	\$7.25
BBD007	¾" MPT Base	\$7.75

Frost-Proof Hydrants

High capacity, top-quality gold hydrants from Boshart Industries.

New design flows up to 25 GPM @ 20 PSI. Which is higher than competitors 1".

MHT outlet x FPT inlet. Overall length: 69" Bury Depth: 3'



Flow Rate GPM @ PSI	
GPM	PSI
16.9	10
25	20
30.9	30
36	40
41	50
44.2	60
48.3	70
52	80

Item #	Size	Price
HYB0073	¾" FPT x 3' Bury	\$102.00

Brass Hydrant Fittings:

Item #	TEE, Insert x MPT	Price
BF 1403007	¾"	\$12.50
BF 1403131	1" x ¾"	\$14.00
Item #	Ell, Insert x MPT	Price
BF 1413007	¾"	\$8.50
BF 1413131	1" x ¾"	\$12.50

Pressure Regulators

These pre-set regulators maintain constant pressure and automatically adjust to flow conditions. **Note:** If water is turned off or flow drops below the flow GPM range these regulators will not regulate the flow.



Item #	Size	PSI	GPM Range	Price
PR 007205	¾" FPT	20	0.5-15	\$9.50
PR 007355	¾" FPT	35	0.5-15	\$9.50
PR 1020	1" FPT	20	2-20	\$13.50
PR 1035	1" FPT	35	2-20	\$13.50
PR 1520	1½" MPT	20	7-35	\$38.00
PR 1535	1½" MPT	35	7-35	\$38.00

Plastic Spin-Clean Filters



Even well water, or other sources of clean water require filtration for irrigation, especially for permanent or reusable systems. Two-piece threaded housing with O-ring seal for easy maintenance. Strong, stainless steel screens. High Pressure: up to 80 PSI. Ball valve for flushing. All repair parts in stock. **Standard Screen:** 150 mesh (100 microns). 200 mesh optional.

Item #	Size	Max Flow	Price
PSF007	¾" MPT	9 GPM	\$23.50
PSF010	1" MPT	18 GPM	\$24.00
PSF015	1½" MPT	55 GPM	\$195.00
PSF020	2" MPT	90 GPM	\$222.00

Plastic Screen Filter

Lightweight stainless steel screen. Housing threads apart for easy screen removal for cleaning. 155 mesh standard. Replacement screens in stock.



Item #	Size	Max Flow	Price
DGF007	¾" FHT x MHT	7 GPM	\$13.00



Battery Operated Controllers



Commercial grade, waterproof, constructed of high impact plastic, these controllers operate on two AA alkaline batteries for up to 3 years. No AC power source required! Fully featured automatic, semi-automatic and manual operation easily programmed with five buttons and easy to read LCD display. Connection: 2 wire.



Single Station with Valve (For specs on valves see listing below.)

Item #	Description	Price
DG710007	Controller with ¾" valve	\$99.00
DG710010	Controller with 1" valve	\$105.00
DG710010P	Propagation Controller with 1" valve	\$112.00
DG710015	Controller with 1½" valve	\$160.00
DG710020	Controller with 2" valve	\$170.00

Multiple Station (Order valves separately below.)

Item #	Description	Price
DG740	Four Station Controller with waterproof cables	\$100.00
DG760	Six Station Controller with waterproof cables	\$107.00

Battery Operated Valves, 2 Wire DC

Heavy duty plastic valves with DC latching solenoid for the above controllers. They feature a manual flow control valve and are normally closed. Connections are all FPT x FPT. Operating Pressure: 10 – 150 PSI.



Item #	Description	Flow Range	Price
DG7007	¾" DC Solenoid Valve	0.1 – 28 GPM	\$39.00
DG7010	1" DC Solenoid Valve	0.2 – 35 GPM	\$39.50
DG7015	1½" DC Solenoid Valve	20 – 135 GPM	\$88.00
DG7020	2" DC Solenoid Valve	30 – 160 GPM	\$93.00

Toro® EVOLUTION® AG Series Controller (Use with 24VAC valves)

Introducing a simple, intuitive and economical controller that gives agricultural and horticultural growers the features they need now! The EVOLUTION® AG, built on the award-winning Evolution platform, allows for modular expansion, fertilizer injection, pulse irrigation, propagation and misting schedules, along with the freedom to program valves to your specific needs: from 1 second to 24 hours. Full Toro Support for programming questions —please call: 877-345-8676. Features a lockable, weather-resistant case. Can run 3 separate programs. Adjust schedules +/- by percentage. Schedule Options: Weekly, Interval, or Looping. Automatic or manual operation.

Optional accessories (not in stock): Wireless soil sensor, wireless weather sensor, wireless handheld remote, wireless auxiliary relay, Smart Connect® plug-in receiver.



Item #	Description	Price
EVO04	Four Station Evolution Controller	\$235.00
EVO04M	4 Station Module (to add-to controller)	\$39.00
EVO12M	12 Station Module (to add-to controller)	\$112.00

Battery Garden Hose Controllers



These garden hose controllers have FHT x MHT and are battery operated. Batteries not included. DG9001D is easy to program with four buttons and an easy to read LCD display. Operates on one 9V battery. Automatic and manual operation. DG900BT is easy to program via DIG BTT free app for Android or iPhone, from up to 50' away. Button is to manually open/close without a smart device. Operates on two AA batteries.



Item #	Description	Price
DG9001D	B09D Digital, Maximum 5.2 GPM & 80 PSI	\$40.00
DG900BT	BOHE-BT Bluetooth, Max 14 GPM & 120 PSI	\$50.00

Mechanical Garden Hose Timer

The Damm® garden hose timer is simple to use, just turn the dial to desired watering time (up to 2 hours) and the timer will automatically stop the water flow at the time you set. Max flow rate: 5 GPM.



Item #	Description	Price
GGA270	Mechanical Garden Hose Timer	\$16.50

Indoor 6 Station AC Controllers

Requires 120 volt AC input and has 24 VAC output for valves, has one 9 volt battery for backup and programming. Fully featured automatic, semi-automatic and manual operation easily programmed with four buttons and easy to read LCD display. 24 VAC valves sold separately, see below.



Item #	Description	Price
DG8006	Six Station AC Controller	\$95.00
DG8006P	Six Station AC Propagation Controller	\$155.00

Electric Solenoid Valves, 24 VAC

Has manual flow control valve & is normally closed. All connections are FPT. Operating Pressure: 10 – 150 PSI.



Item #	Description	Flow Range	Price
EV 007	¾" AC Solenoid Valve, 24V	0.1 – 28 GPM	\$22.50
EV 010	1" AC Solenoid Valve, 24V	0.2 – 35 GPM	\$21.50
EV 015	1½" AC Solenoid Valve, 24V	20 – 140 GPM	\$80.00
EV 020	2" AC Solenoid Valve, 24V	30 – 170 GPM	\$86.00

Blue Layflat

This general purpose blue layflat is a lightweight, tough, and economical water discharge hose great for main supply lines. It will not rot or mildew and coils flat for easy storage.

Item #	Description	Max PSI	Roll Wt.	Price	3+ Rolls
LAY015	1½" x 300' Blue Layflat	80 PSI	48 Lbs.	\$118.00	\$114.50
LAY020	2" x 300' Blue Layflat	80 PSI	63 Lbs.	\$134.00	\$130.00



Blue Stripe® Oval Hose

Blue Stripe® Oval Hose is a lightweight economical tubing made from premium grade polyethylene. Can be punched. Used with insert fittings and clamps.



Item #	Description	Max PSI	Roll Wt.	Price
FPT1515	1½" x 150' Oval Hose	21 PSI	16 Lbs.	\$51.00
FPT2015	2" x 150' Oval Hose	21 PSI	24 Lbs.	\$62.00

Black Poly Pipe

This semi-rigid black utility poly tubing is useful for underground, well, or high pressure applications. Not punchable.



Item #	Description	PSI Rating	Price	Ship Via
BPP07100	¾" x 100'	100 PSI	\$28.50	Ground
BPP10100	1" x 100'	100 PSI	\$35.00	Freight
BPP10300	1" x 300'	100 PSI	\$99.00	Freight

Some other sizes and PSI ratings available. Takes 3+ weeks to get. Call Nolt's Produce Supplies for pricing and details.

Toro® Aqua-Traxx® Drip Tape

Typically used as a single year alternative to Blueline (see below), but isn't pressure compensating. Engineering-grade virgin resins and seamless construction add durability. The PBX Advantage increases durability, clog resistance and uniformity to set Aqua-Traxx apart from lesser drip tapes. For other sizes, spacings, and thicknesses contact: Nolt's Produce Supplies (717.656.9764)

Item #	Description	Spacing	Flow/100'	Flow/Emitter	Price	16+
AQ 101838	Aqua-Traxx® 10 mil, 6,000 ft.	18"	0.38 GPM	0.34 GPH	\$172.00	\$166.00
AQ 102428	Aqua-Traxx® 10 mil, 6,000 ft.	24"	0.28 GPM	0.34 GPH	\$172.00	\$166.00



BlueLine® PC Pressure Compensating Dripline

18MM (½") Orchard Tubing with Built-In Emitters

Features a unique, built-in flow regulated emitter, providing a constant discharge over a pressure range of 15-60 PSI. The emitter is inseparably welded to the inside wall of the tubing as it is extruded in the manufacturing process. Emitters are factory installed at pre-determined intervals. This one-piece construction prevents damage and loss of drippers, eliminates hole punching and handling damage, reduces installation costs.

BlueLine™ PC may be hung on a wire, laid on the surface or buried. Typically used in orchards, vineyards, over top of containers/mum pots, nurseries, or buried in fields for subsurface applications. Stock Flow: 0.53 GPH per emitter.

Item #	Description	Emitter Spacing	Price
DRP1812	18 MM (½") x 1000'	12" spacing	\$150.00
DRP1818	18 MM (½") x 1000'	18" spacing	\$145.00
DRP1824	18 MM (½") x 1000'	24" spacing	\$135.00
DRP1830	18 MM (½") x 1000'	30" spacing	\$133.00
DRP1836	18 MM (½") x 1000'	36" spacing	\$130.00
DRP16	Plastic Stake to secure ½" tubing		\$0.22



Raised inlets ensure that sediment deposits at the bottom of the tube do not enter the emitter.



Streamlined nature of the emitter encourages debris to pass by rather than enter the inlets.

Blue Stripe® Orchard Tubing

This lightweight polyethylene tubing is punchable and is often used for a lateral distribution & supply hose for on-line drippers, weighted drip tubes, micro-sprinklers and can be used as a headline for small drip tape systems.



Item #	Description	Max PSI	Roll Wt.	Price
BPT0051	½" x 100' Orchard Tubing	68 PSI	5 Lbs.	\$17.00
BPT0055	½" x 500' Orchard Tubing	68 PSI	22 Lbs.	\$45.00
BPT0059	½" x 1,000' Orchard Tubing	68 PSI	44 Lbs.	\$86.00
DRP16	Plastic Stake to secure ½" tubing	—		\$0.22
BPT0071	¾" x 100' Orchard Tubing	54 PSI	8 Lbs.	\$22.00
BPT0075	¾" x 500' Orchard Tubing	54 PSI	36 Lbs.	\$64.00
BPT0101	1" x 100' Orchard Tubing	53 PSI	10 Lbs.	\$31.00
BPT0102	1" x 250' Orchard Tubing	53 PSI	24 Lbs.	\$64.00

White Orchard Tubing

White exterior, which reflects the sun and keeps the water cooler.

Item #	Description	Max PSI	Roll Wt.	Price
WPT0055	½" x 500' Orchard Tubing	68 PSI	22 Lbs.	\$65.00
WPT0075	¾" x 500' Orchard Tubing	54 PSI	36 Lbs.	\$88.00



PC Anti Drain Drainers

These can be punched into orchard tubing and are used in vineyards, orchards, nurseries and greenhouses. Anti-drain and pressure compensating. Toro Press. Range: 15–60 PSI. Netafim Press. Range: 11–58 PSI.



Item #	Description	Price	500+
PCD005	Blue, 0.5 GPH w/Nipple for Spiders	\$0.25	\$0.22
PCD010	Gray, 1.0 GPH w/Nipple for Spiders	\$0.25	\$0.22
PCD020	Red, 2.1 GPH w/Nipple for Spiders	\$0.25	\$0.22
NDT005	WPJC Netafim Red, 0.5 GPH w/Barb	\$0.32	\$0.29
NDT010	WPJC Netafim Grey, 1.0 GPH w/Barb	\$0.32	\$0.29

White Spider Assemblies

Multi-outlet device for PCD drippers. These four outlet assemblies are commonly used for mums and other potted plants. They have straight stakes which allows for easy removal from established plants. Use with above PCD drippers.



Item #	Description	Pack of 10	Case of 100
NGE418	Spider, 4 x 18" tubes	\$10.80	\$96.00
NGE424	Spider, 4 x 24" tubes	\$11.50	\$103.00
NGE430	Spider, 4 x 30" tubes	\$12.20	\$110.00
NGE436	Spider, 4 x 36" tubes	\$13.00	\$118.00

Spider Components

Make your spiders to water anywhere from 1 to 6 pots per dripper using 1/8" spaghetti tubing (below).



Tees, crosses, and adapters can be combined.

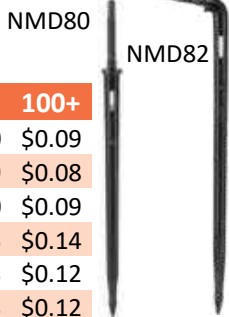

Item #	Description	1-99	100+
NGEF1	Single Outlet Adapter	\$0.10	\$0.09
NGEF2	Two Outlet Tee	\$0.09	\$0.08
NGEFM2	Two Outlet Cross	\$0.10	\$0.09
NGEF4	Four Outlet Cross	\$0.15	\$0.14
NMD82	Dripper Stake, Elbowed	\$0.13	\$0.12
NMD80	Dripper Stake, Straight	\$0.13	\$0.12

Spaghetti Tubing

Item #	Description	Dimensions	Price
BVT0012	Black 1/8" x 100'	0.187" OD x 0.118" ID	\$7.00
BVT00121	Black 1/8" x 1000'	0.196" OD x 0.126" ID	\$40.50
WVT00121	White 1/8" x 1000'	0.196" OD x 0.126" ID	\$55.00
BVT0018	Black 3/16" x 100'	0.250" OD x 0.170" ID	\$8.00
BVT00181	Black 3/16" x 1000'	0.250" OD x 0.170" ID	\$59.00

Barb to Barb Couplings

Item #	Description	1-99	100+
TB 125	1/8" Barb Couplings	\$0.10	\$0.08
TB 170	3/16" Barb Couplings	\$0.10	\$0.08

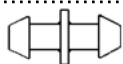

Netafim™ Pot Drippers



SlimLine EZ Close Assemblies combines the benefits of:

- One-hand, EZ close shut-off of individual baskets – prevents water and fertilizer spillage and waste
- Snag-free slim design for easy retrieval from plants at harvest – no more lost weights
- 94% flow uniformity – from the first basket to the last

For 1 gph or custom length: Assemble your own using NDT001 weight, WVT00121 tubing and NDT005 or NDT010 drippers.

Dripper: WPJC dripper, anti-drip and pressure compensating.

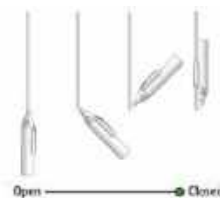

Assemblies Sold 25/Pack

Item #	Description	25-475	500+
NDT24	Pot Dripper, 24" tube, 1/2 gph	\$0.81	\$0.77
NDT36	Pot Dripper, 36" tube, 1/2 gph	\$0.87	\$0.83
NDT48	Pot Dripper, 48" tube, 1/2 gph	\$1.10	\$1.06
NDT001	Slimline Plastic Weight/Shutoff	\$0.52	\$0.48

JAIN On/Off Twist Weights

These plastic on/off twist weights come with 0.060" ID tubing. Not pressure compensating, used for fast watering. Max of 50' row lengths when using 1/2" supply line.



Item #	Description	1-99	100+	500+
COT24	On/Off Twist Weight, 24" tube	\$1.18	\$1.11	\$1.08
COT36	On/Off Twist Weight, 36" tube	\$1.24	\$1.17	\$1.14
COT48	On/Off Twist Weight, 48" tube	\$1.32	\$1.25	\$1.22

Pressure Compensating, 0.5 GPH

MicroFlappers® elbow. You can put these on above Jain drippers to make them pressure compensating. To do that you'll need 1.5" length of BVT0012 0.118" ID tubing each. Uniform flow regardless of pressure, elevation, and length of supply line. Operating Pressure: 15–45 PSI.

Item #	Description	1-99	100+
COT905	0.5 GPH Emitter, 90° Ell	\$0.42	\$0.39

Pot Spray Stakes

Provides consistent flow and 160° spray pattern. Unique positioning arrow indicates flow. Flow rate @ 20 psi. Use 1/8" or 3/16" couplings & spaghetti tubing.

Item #	Description	1-99	100+
PSS05	Pot Spray Stake, 6.4 GPH, Black	\$0.25	\$0.22
PSS10	Pot Spray Stake, 10.5 GPH, Blue	\$0.25	\$0.22
PSS15	Pot Spray Stake, 16.0 GPH, Green	\$0.25	\$0.22



Goof Plugs

Plugs holes 1/8" – 1/4" in diameter in poly tubing.

Item #	Description	Price
OTFMP1	Goof Plugs, Pack of 10	\$0.50



NaanDan Jain® Foggers/Misters

Performance Micro-Sprinklers and Sprayers

Commonly used for propagation, cooling and humidification in greenhouses. Contact us for design information. Recommended Pressure: 55 – 60 PSI.

For mounting/hanging options see Modular Group Sprinklers/Sprayers on page 33.



Installation Recommendations:

One fogger should be used for every 2.5 square feet. The cross with four foggers will cover an area up to 10 square feet (3 – 4 feet wide).

Foggers should be installed at a height of 3 – 5 feet above the propagation material.

The spacing between the fogger assemblies should be 3 feet.

Multiple flow rates available for different precipitation rates.

3' – 4' Bench: One line above the center.

6' – 7' Bench: Two lines with crosses are required.

To prevent dry edges on a single bench (no other benches within 2') the cross should not be further than 1' from the edge. In some instances two lines may be required on a 4' bench.

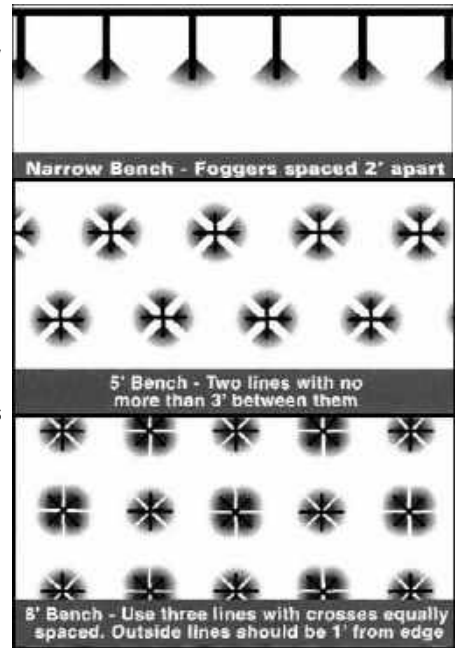

Item #	Description	Price
NMF018	Blue Fogger, 1.8 GPH	\$1.69
NMF036	Orange Fogger, 3.6 GPH	\$1.69
NMF054	Red Fogger, 5.4 GPH	\$1.69
NMF072	Black Foggers, 7.2 GPH	\$1.69
NMF2	LPD (Anti-Drip), Opens at 55 PSI, Closes 35 PSI	\$2.25
NMFX	4 Way Cross	\$2.00
NMFT	2 Way Tee	\$1.90
NMF45	45° Angle Adapter	\$0.60
NMFP	Plug	\$0.40

Drip Tape Fittings

For 5/8" Drip Tape.



Item #	Description	1-49	Bag/50
DTFCPT	Tape Loc Coupling	\$0.45	\$0.40
DTFEND	Tape Loc End Plug	\$0.45	\$0.40
DTF400B	.40" Barb x Tape Loc	\$0.40	\$0.35
DTF400BV	.42" Barb x Tape Loc w/Valve	\$1.50	\$1.35
DTF400PIAG	Gauge Adp, .40" Barb x 1/4" FPT	\$2.00	–
DTFFHCBV	Layflat x Tape Loc with Valve	\$1.75	\$1.55
DTFFHC	Layflat x Tape Loc	\$0.95	\$0.80
DTFHEX	Installation Tool for HL FHC & DTFFHC(BV), not a punch.	\$6.25	–
DTFFHP2	16 MM Layflat Punch, for DTFFHC(BV) & HL FHC	\$64.00	–

Ejector Punches

Threaded tips are replaceable. Works with all sizes orchard tubing and oval hose.



Item #	Description	Use	Price
DTFAP02	Ejector Punch, 2.5 MM	1/8" & 3/16" Barbs; Drippers	\$10.00
DTFAP07	Ejector Punch, 7.0 MM	0.40" - 0.425" Barbs	\$10.00
Replacement Punch Tips			
DTFAPT02	2.5 MM Replacement Tip		\$4.80
DTFAPT07	7.0 MM Replacement Tip		\$4.80

Item #	Description	Use	Price
OTFDP4R	Easi-Punch w/ 2 MM Red Tip	COT	\$15.00
OTFDP4B	Easi-Punch w/ 3 MM Blue Tip	COT1; 1/8" & 3/16" Barbs	\$15.00
OTFDPT	Replacement Tips for Easi-Punches		\$9.00

Easy Loc Fittings

For 1/2" Orchard Tubing and 18 MM BlueLine PC.

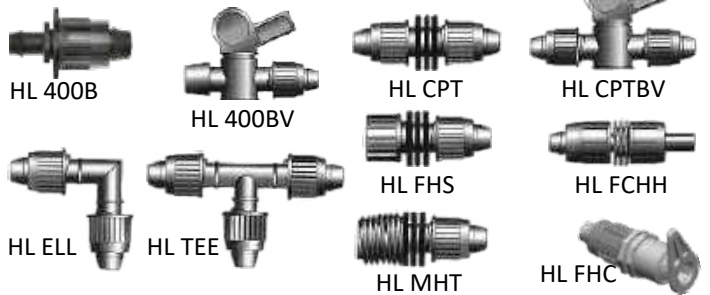

Item #	Description	1-49	Bag/50
HL 400B	0.425" Barb x 600s Loc	\$0.60	\$0.55
HL 400BV	0.425" Barb x 600s Loc w/Valve	\$1.50	\$1.35
HL CPT	Coupling, 600s Loc	\$0.55	\$0.50
HL CPTBV	Coupling, 600s Loc with Valve	\$1.85	\$1.65
HL ELL	90° Ell, 600s Loc	\$1.20	\$1.10
HL TEE	Tee, 600s Loc	\$1.40	\$1.25
HL FHC	Layflat x 600s Loc	\$1.20	\$1.10
HL FHS	Hose Adapter, FHT x 600s Loc	\$1.10	\$1.00
HL MHT	Hose Adapter, MHT x 600s Loc	\$0.65	\$0.60
HL MA	1/2" MPT x 600s Loc	\$0.50	\$0.45
HL FCHH	End, Auto-Flush x 600s Loc	\$1.70	\$1.55

Easy Loc Fittings For 3/4" Orchard Tubing.

NEW FOR 2025

Item #	Description	1-49	Bag/50
HL7CPT	Coupling, 800s Loc	\$1.30	\$1.15
HL7CPTBV	Coupling, 800s Loc with Valve	\$2.00	\$1.80
HL7ELL	90° Ell, 800s Loc	\$1.90	\$1.75
HL7FHS	Hose Adapter, FHT x 800s Loc	\$1.90	\$1.75
HL7MHT	Hose Adapter, MHT x 800s Loc	\$1.40	\$1.25
HL7TEE	Tee, 800s Loc	\$2.00	\$1.80

Easy Punch

Easy to hold and easy to use. Punches 1/2" and 3/4" orchard tubing. Remove blue insert for 3/4" tubing.



Modular Micro Sprinklers

Performance Micro-Misting and Irrigation Solutions



NOZZLES					SPREADERS		SPINNERS					
					NMS51	NMS52	NMS41	NMS40	NMS43	NMS42		
					Violet Misting	Yellow Flat	Black Round	Blk. Single Wing	Orange Round	Kiwi Inverted		
Item #	Color	Size	Flow Rate		Hanging Height (ft)							
			gph	gpm							2'	6'
NMS032	Violet	.032"	9.2	.15	4'	6'	17'	20'	NA	16'	20'	
NMS044	Grey	.046"	18.4	.31	NA	8'	18'	22'	NA	19'	25'	
NMS055	Green	.056"	27.7	.46	NA	10'	19'	24'	30'	21'	27'	
NMS060	Orange	.059"	31.7	.53	NA	12'	20'	25'	30'	26'	29'	
NMS067	Yellow	.068"	42.2	.70	NA	NA	21'	26'	30'	28'	31'	
NMS075	Blue	.076"	52.8	.88	NA	NA	NA	28'	30'	29'	33'	
NOTE: All diameters (except kiwi) are based on 30 psi and 24" above crop canopy. For best coverage uniformity, recommended sprinkler spacing is 3' regardless of operating diameter. Because of wind drift, recommended for indoor use only.					upright / inv.	upright / inv.	upright / inv.	upright only	upright / inv.	inverted		
					Designed for misting of propagation tables and adding moisture for cooling.	Flat water pattern with highly uniform coverage. Large droplet size.	Designed for medium coverage with a medium sized droplet.	Designed for large coverage and large droplet size.	Designed for the largest coverage and largest droplet size. Very little misting.	Designed for inverted installation in overhead systems. Medium to large droplet size.		

Greenhouse Hanging Assembly

Includes:

- Nozzle,
- Spinner,
- Bridge,
- LPD,
- Stabilized Hanging Tube

Length	Price
24"	\$5.73
36"	\$5.88
48"	\$6.03

Bridge Assembly (Butterfly)

Includes:

- Nozzle,
- Spinner,
- Bridge,
- Butterfly

Price
\$1.93

Upright Assembly

Includes:

- Nozzle,
- Spinner,
- Bridge,
- Stabilized Hanging Tube
- 12" Stake

Tube Length	Price
24"	\$4.33
36"	\$4.48
48"	\$4.63

Bridge Assembly

Includes:

- Nozzle,
- Spinner,
- Bridge

Price
\$1.38

Nozzle & Anti-mist

Specify Color

Item #	Description	Price
NMS0*	Nozzle	\$0.28
NMS6*	Antimist	\$0.40

Spreaders

Item #	Size	Price
NMS5*	Specify Color	\$0.35

Spinners

Item #	Size	Price
NMS4*	Specify Color	\$0.35

Bridge

Item #	Description	Price
NMS3	Bridge	\$0.75

Stabilized Hanging Tubes, (Tube, stabilizer and butterfly mount)

Plastic Stakes, 12"
(See Upright Assembly for use illustration)

Item #	Size	Price
NMS124	24" Tube	\$2.10
NMS136	36" Tube	\$2.25
NMS148	48" Tube	\$2.40
NMS314	12" Stake	\$0.85

Butterfly Mount

Item #	Description	Price
NMS33	Butterfly Mount	\$0.55

1/2" Male Threaded Base

Item #	Description	Price
NMS35	1/2" Male Base	\$0.95

Agri-Connector

1/2" FPT x 3/16" Barb

Item #	Description	Price
NMS1	Agri-Connector	\$0.85

LPD (Anti-Drip)

Opens at 20 PSI
Closes at 9 PSI

Item #	Size	Price
NMS2	LPD (Anti-Drain)	\$2.25

3/16" Barb Connector

Item #	Size	Price
TB 170	3/16" Barb	\$0.10

3/16" Black Vinyl Tubing

To make custom length tubes.

Item #	Description	Price
BVT0018	3/16" x 100'	\$8.00
BVT00181	3/16" x 1000'	\$59.00

Irrigation & Fittings

LED Grow Lights

These LED grow lights are designed for supplemental light—not intended to be able to grow plants without the aid of sunshine. Standalone design—no fixture needed—these LED tube lights are easy to install with included hardware.

- No wiring needed when using our integrated cords. Daisy chain up to 2 lights (96 watts). You can daisy chain more, but that voids warranty.
- **Energy saving:** Uses less energy and produce less heat than full spectrum lights. 100% of the power input is used for your plant chlorophyll production.
- These lights have special red & blue mixing LED bulbs. 3 parts red for every 2 parts blue. Different color light helps plants achieve different goals. The blue light helps encourage vegetative leaf growth. Red light, when combined with blue, allows plants to flower. *Call for prices on quantities of 48 or more.*



Item #	Description	1-11	12+
GL0445	47" Tube LED Grow Light, 45 Watt (T8 size)	\$36.00	\$33.00
GLC05S	5' Cord with switch, outlet to light	\$8.00	\$7.25
GLC10S	10' Cord with switch, outlet to light	\$10.50	\$9.50
GLC02	2' Cord, light to light	\$3.60	\$3.25
GLC03	3' Cord, light to light	\$4.70	\$4.25
GLC05	5' Cord, light to light	\$7.70	\$7.00

Senninger® Mini-Wobblers

Low-angle trajectory & good droplet size reduce wind drift and distortion of the spray pattern. Space & stagger these sprinklers at 30% less than listed diameter for uniform coverage.



Operating Pressures: 15-25 PSI (Upright); 20-25 PSI (Inverted).
Connections: 1/2" MPT.

Item #	Description	Price
Upright mini-Wobbler®		
WOM04	Upright mini-Wobbler, #4 Blue Nozzle	\$3.95
WOM05	Upright mini-Wobbler, #5 Beige Nozzle	\$3.95
WOM06	Upright mini-Wobbler, #6 Gold Nozzle	\$3.95
WOM07	Upright mini-Wobbler, #7 Lime Nozzle	\$3.95
WOM08	Upright mini-Wobbler, #8 Lavender Nozzle	\$3.95
Inverted mini-Wobbler®:		
WOI05	Inverted mini-Wobbler, #5 Beige Nozzle	\$3.95
WOI06	Inverted mini-Wobbler, #6 Gold Nozzle	\$3.95

mini-Wobbler, Upright

Diameter calculated at 1.5' height.

Nozzle Color	Light Blue	Beige	Gold	Lime	Lavender					
Nozzle Size	#4 1/16"	#5 5/64"	#6 3/32"	#7 7/64"	#8 1/8"					
Nozzle PSI	GPM	DIA.	GPM	DIA.	GPM	DIA.				
15	0.42	26.5	0.64	31.0	0.95	33.0	1.30	35.0	1.67	35.5
20	0.50	28.0	0.75	33.5	1.10	36.0	1.51	37.5	1.95	38.5
25	0.56	28.0	0.84	35.0	1.25	37.0	1.69	38.5	2.18	43.0

i-mini-Wobbler, Inverted

Diameter calculated at 6' height.

Nozzle Color	Beige	Gold		
Nozzle Size	#5 5/64"	#6 3/32"		
Nozzle PSI	GPM	DIA.	GPM	DIA.
20	0.75	32.0	1.10	34.0
25	0.84	32.5	1.25	34.5

Riser Assembly 1/2" FPT x barb.

Use DTFAP07 punch. Use 1/2" or 3/4" pipe or 5/16" rod for stake.

Item #	Description	Price
WOR136	W/36" tube	\$3.70
WOR148	W/48" tube	\$3.85

Replacement Nozzles:

WOT04	#4 Blue Nozzle for mini-Wobbler	\$0.70
WOT05	#5 Beige Nozzle for mini-Wobbler	\$0.70
WOT06	#6 Gold Nozzle for mini-Wobbler	\$0.70
WOT07	#7 Lime Nozzle for mini-Wobbler	\$0.70
WOT08	#8 Lavender Nozzle for mini-Wobbler	\$0.70

Senninger® Xcel-Wobblers

The Xcel-Wobbler uses Senninger's off-center rotary-action technology. It provides an extremely uniform and instantaneous application pattern over a large area at lower pressures, and with very low evaporative loss and wind drift. Wobblers are designed for nursery irrigation and frost protection. Wobblers installed in test bed withstood winds up to 25 MPH and temperatures as low as 18°. They are an excellent sprinkler for small diameters from 35 to 56 feet. The Xcel has less vibration than earlier models.



Diameter at 1.5' height.

Item #	Description	Price
WOBX06	Xcel-Wobbler, #6 Gold Nozzle	\$7.50
WOBX08	Xcel-Wobbler, #8 Lavender Nozzle	\$7.50
WOBX10	Xcel-Wobbler, #10 Turquoise Nozzle	\$7.50
WOBX12	Xcel-Wobbler, #12 Red Nozzle	\$7.50
Replacement Nozzle:		
WOB06	#6 Gold Nozzle for Xcel-Wobbler	\$0.80
WOB08	#8 Lavender Nozzle for Xcel-Wobbler	\$0.80
WOB10	#10 Turquoise Nozzle for Xcel-Wobbler	\$0.80
WOB12	#12 Red Nozzle for Xcel-Wobbler	\$0.80
WOB14	#14 Blue Nozzle for Xcel-Wobbler	\$0.80
WOB16	#16 Orange Nozzle for Xcel-Wobbler	\$0.80

Connection: 1/2" MPT.

Operating Pressures: 10 – 25 PSI.

Space & stagger these sprinklers at 30% less than listed dia. for uniform coverage.

Nozzle Color	Gold	Lavender	Turquoise	Red	Blue	Orange						
Nozzle Size	#6 3/32"	#8 1/8"	#10 5/32"	#12 3/16"	#14 7/32"	#16 1/2"						
Nozzle PSI	GPM	DIA.	GPM	DIA.	GPM	DIA.	GPM	DIA.				
10	0.78	36.5	1.40	42.0	2.22	44.5	3.23	46.0	4.40	47.0	5.61	48.0
15	0.95	41.0	1.71	46.5	2.72	49.0	3.96	50.5	5.39	51.0	7.88	52.5
20	1.10	45.0	1.98	47.0	3.14	50.5	4.57	52.0	6.23	53.0	9.63	55.0
25	1.23	46.0	2.21	51.5	3.51	53.5	5.11	54.5	6.97	55.5	11.01	56.5



Black Woven Ground Cover

This woven polypropylene fabric is UV stabilized, extremely strong, water and air permeable and far superior to sheet plastic. Effective weed blocker. 3.2 oz./sq. yd. with stripes every foot.

Item #	Size	1-5	6+	Ship Via	Weight
BGC03	3' x 300'	\$39.00	\$37.00	Ground	25 Lbs.
BGC04	4' x 300'	\$51.50	\$49.00	Ground	33 Lbs.
BGC06	6' x 300'	\$76.50	\$73.00	Ground	50 Lbs.
BGC08	8' x 300'	\$102.00	\$97.00	Truck	67 Lbs.
BGC10	10.5' x 300'	\$133.00	\$127.00	Truck	87 Lbs.
BGC12	12.5' x 300'	\$157.00	\$150.00	Truck	104 Lbs.
BGC15	15.5' x 300'	\$195.00	\$186.00	Truck	130 Lbs.

UltraWeb Black Woven Ground Cover

Lighter weight UV stabilized, woven cloth is extremely strong and far superior to sheet plastic. This woven polypropylene fabric is water and air permeable yet blocks weeds effectively. Popular for seed beds, stronger and easier to handle than silage tarps. 2.2 oz./sq. yd. with stripes every foot.

Item #	Size	1-5	6+	Ship Via	Weight
UGC24	24' x 200'	\$163.00	\$155.00	Truck	89 Lbs.
UGC32	32' x 150'	\$163.00	\$155.00	Truck	89 Lbs.
UGC40	40' x 120'	\$163.00	\$155.00	Truck	89 Lbs.

White Thermal Blanket, Frost Protection

A white, non-woven, needle punched polypropylene fabric. Provides 10°+ frost protection, but transmits little light, mostly used to overwinter or cover dormant nursery stock. 2.5 oz./sq. Yd.

Item #	Description	Price
WFB06	White Thermal Blanket, 6' x 250'	\$205.00
WFB12	White Thermal Blanket, 12' x 250'	\$390.00
WFB15	White Thermal Blanket, 15' x 250'	\$475.00

For thinner frost protection covers:

Contact **Nolt's Produce Supplies, LLC** — 717.656.9764
They sell 1.25 oz Typar and 1 and .55 oz Dewitt.

Black Knitted Shade Cloth, 50% Shade

In Stock. 100% UV stabilized polyethylene with a lock stitch construction that keeps edges from unraveling. The material to be cut to exact size on job site with household scissors. "Clip-its" for 4ft spacing, on length of both sides are supplied at no extra charge.

Item #	Description	1 - 94'	95'+
GSC5026	26' Shade Cloth, 50% Black Knitted	\$4.20	\$3.80
GSC5034	34' Shade Cloth, 50% Black Knitted	\$5.00	\$4.50
GSC10	Plastic Clip-its (folds & clamps to secure)	\$0.26	-

Custom sizes and other shade percentages are also available. Allow two weeks for delivery on custom orders. Call us for pricing. Available shade percentages: 30%, 40%, 50%, 60%, 70%, 80%, 90%.

White on Black Woven Ground Cover

3.8 oz./sq. Yd. Turn white up to reflect the sun and heat.

For applications where cooler soil & sunlight reflection is preferred. Very similar to our black woven ground cover, except stronger, and this product has white and black strands interwoven. Mostly white on top side (to reflect sun & heat) and mostly black on the opposite side (underside) to block weeds. Maybe not as effective at preventing weed seed germination as black, but better than all white. Can also get 3.2 oz. White, call for prices & sizes.



Item #	Size	1-5	6+	Ship Via	Weight
WBG03	3' x 300'	\$62.00	\$59.00	Ground	30 lbs.
WBG06	6' x 300'	\$123.00	\$118.00	Ground	60 lbs.
WBG12	12' x 300'	\$243.00	\$233.00	Truck	120 lbs.
WBG15	15' x 300'	\$302.00	\$290.00	Truck	150 lbs.

Steel Sod Staples

To secure woven ground covers.



Item #	Description	Price	5+
SS88	HD Staples, 8" x 1", 8 gauge, 500/box	\$41.00	\$39.00
SS611	Staples, 6" x 1", 11 gauge, 1,000/box	\$37.00	\$35.00

DeWitt Custom Woven Shade Cloth

Custom order: Allow two weeks for delivery. This woven shade cloth is made from 100% polypropylene monofilament strands. UV stabilized, outlasts knitted shade cloth. DeWitt's sewing team can customize panels to any size. They use #4 brass grommets and 2-3/4" reinforcement tape, along the edges, which are double stitched for extra holding power.



Available Shade Percentages: 30%, 47%, 55%, 63%, 73%, & 80%. Standard widths are 6, 10', & 12' and any of these can be seamed together and even cut to make your width.

For a custom quote or to order: determine your required width, length, shade percentage and grommet spacing. Ships direct from manufacturer. Call for price quote, or to place an order.

Kool Ray Shade, Classic

Concentrated liquid shade. Common dilution rate is 1 part to 8 parts water, which reduces light transmission 31%. 1:3 ratio reduces light 45%. 1:1 ratio reduces light 65%. One gallon of solution covers 175 sq. ft. Can be applied by brush, roller or spray, but works best when spray applied. Usually applied in spring or summer then during the course of the year, the shading will slowly wear off allowing for increased light levels as the daylight decreases. Frost will also loosen shade. Keep product from freezing.



Item #	Description	Price	4+
KRS1	Kool Ray Classic Shade, 1 gallon	\$42.00	\$40.00
KRS5	Kool Ray Classic Shade, 5 gallon	\$165.00	



Hanging Basket Display Rack

Holds approximately 25 baskets. Constructed from 14 ga. Gatorshield® Galvanized square tubing. It has 2 solid casters on one end and 2 swivel casters on the other end. Collapsible. Dimensions: 7' high, 8' long, 4' wide at the base.



Item #	Description	Price	10+
FR 5	Display Rack, 5" solid rubber casters (with brakes)	\$302.00	\$290.00
FR 10	Display Rack, 10" flat free tires (no brakes)	\$430.00	\$415.00

Plant Transport Cart

- All metal construction
- Green powder coat paint
- 56½" long x 21" wide x 82½" high – PTC4 (84¾" high – PTC4L)
- Cart has tow hitch and coupling
- Shelves are 2" x 2" wire grid
- Each shelf holds 5 true 1020 trays or 4 standard 1020 trays, and other common pot trays
- 22 shelf rests on 3" centers
- Price includes the base and 4 removable shelves



PTC4S



PTC4

Item #	Description	Price	10+
PTC4	Plant Transport Cart, with 4 shelves 6 x 2" casters (rubber over cast iron)	\$408.00	\$393.00
PTC4L	Plant Transport Cart, with 4 shelves 8" Foam Filled Pneumatic Wheels	\$526.00	\$510.00
PTC4S	Additional Shelves	\$31.20	\$30.00

Nursery Cart

Wheelbarrow style with stops to prevent it from tipping forward. Quality green paint. Two 13" flat free tires. Bed Dimensions: 60" Length x 28" Width x 19" Height



PTC1

Greenhouse Shopping Carts

This handy greenhouse cart features handles on both ends. Painted green. 10" flat free tires, 2 swivel & 2 rigid. Dimensions:

- Double Deck Cart:
40" Length x 21" Width x 34" Height
- Triple Deck Cart:
48" Length x 21" Width x 43" Height

PTC2



PTC3

Item #	Description	Price
PTC1	Two-wheeled Nursery Cart	\$400.00
PTC2	Double Deck Shopping Cart	\$400.00
PTC3	Triple Deck Shopping Cart	\$515.00



Greenhouse Plastic

We sell both Tufflite IV™ and Klerks K50 in order to provide best price and availability. If you have a brand preference let us know. Otherwise you get whatever we have on hand at the time. Both brands are a high-quality greenhouse covering offering high clarity to allow the most light possible. They also feature tri-layer extrusion and dust resistance. Discounts on orders over \$2500.

Standard, Clear, 6 mil, 4 year					
Item #	Size	Price	Item #	Size	Price
T4614	14' x 100'	\$126.00			
T4620	20' x 100'	\$180.00	T4620150	20' x 150'	\$270.00
T4624	24' x 100'	\$216.00	T4624150	24' x 150'	\$324.00
T4628	28' x 100'	\$252.00			
T4632	32' x 100'	\$288.00	T4632150	32' x 150'	\$432.00
T4636	36' x 100'	\$324.00	T4636150	36' x 150'	\$486.00
T4640	40' x 100'	\$360.00	T4640150	40' x 150'	\$540.00
T4642	42' x 100'	\$378.00	T4642150	42' x 150'	\$567.00
T4648	48' x 100'	\$432.00	T4648150	48' x 150'	\$648.00
T4650	50' x 100'	\$450.00	T4650150	50' x 150'	\$675.00
K4654	54' x 100'	\$486.00	K4654150	54' x 150'	\$729.00
T4656	56' x 100'	\$504.00	T4656150	56' x 150'	\$756.00

Infrared™ is a 4 year, 6 mil, energy saving greenhouse covering. Features single sided Drip-Less, anti-condensate, along with an additive that retains infrared waves, which improves nighttime heat retention. Light diffusing – reduces shadows. Use for the bottom layer in double layer installations.

Infrared™, Clear, 6 mil, 4 year					
Item #	Size	Price	Item #	Size	Price
TES20	20' x 100'	\$200.00	TES20150	20' x 150'	\$300.00
TES24	24' x 100'	\$240.00			
TES28	28' x 100'	\$280.00			
TES32	32' x 100'	\$320.00	TES32150	32' x 150'	\$480.00
TES36	36' x 100'	\$360.00	TES36150	36' x 150'	\$540.00
TES40	40' x 100'	\$400.00	TES40150	40' x 150'	\$600.00
TES42	42' x 100'	\$420.00	TES42150	42' x 150'	\$630.00
TES48	48' x 100'	\$480.00	TES48150	48' x 150'	\$720.00
TES50	50' x 100'	\$500.00	TES50150	50' x 150'	\$750.00
KES54	54' x 100'	\$540.00	KES54150	54' x 150'	\$810.00
TES56	56' x 100'	\$560.00	TES56150	56' x 150'	\$840.00

Nursery Clear™

Clear, 4 mil, 1 year. Used on seasonal structures.					
Item #	Size	Price	Item #	Size	Price
TNC24	24' x 100'	\$120.00	TNC24150	24' x 150'	\$180.00
TNC32	32' x 100'	\$160.00	TNC32150	32' x 150'	\$240.00
TNC40	40' x 100'	\$200.00	TNC40150	40' x 150'	\$300.00

White Copoly, 70% Shade

Used for over-wintering of dormant stock or on storage structures.

White Copoly, 4 mil, 1 year					
Item #	Size	Price	Item #	Size	Price
T4W24	24' x 100'	\$120.00	T4W24150	24' x 150'	\$180.00
T4W32	32' x 100'	\$160.00	T4W32150	32' x 150'	\$240.00
T4W40	40' x 100'	\$200.00	T4W40150	40' x 150'	\$300.00

Klerks Koolite Plus



This 4 year, 6 mil, UV stabilized covering allows 84% light transmission, yet lowers greenhouse air temperature by 10 degrees compared to traditional greenhouse films. Also features light diffusion (53%), 2 sided anti-condensate, and IR additives that re-radiate nighttime infrared heat.

Koolite Plus, 6 mil, 4 year					
Item #	Size	Price	Item #	Size	Price
KKL32	32' x 100'	\$435.20	KKL32150	32' x 150'	\$652.80
KKL36	36' x 100'	\$489.60	KKL36150	36' x 150'	\$734.40
KKL42	42' x 100'	\$571.20	KKL42150	42' x 150'	\$856.80
KKL48	48' x 100'	\$652.80	KKL48150	48' x 150'	\$979.20

Need a plastic size that we don't list? We can get almost any size, in all listed greenhouse films. Lead time: 2 - 8 weeks.

Poly Patch Greenhouse Tape

A rugged patching tape that is perfect for mending greenhouse rips and tears. Clear, polyethylene tape with a medium tack acrylic-based adhesive.



Item #	Description	Price
PPT02	2" x 48' with poly coated release liner	\$9.10
PPT04	4" x 48' with poly coated release liner	\$17.00
PPT04-NL	4" x 54' NO liner	\$13.00
PPT06	6" x 48' with poly coated release liner	\$24.50

Inflation Blowers

For inflating double layered film on greenhouses. 120VAC. Pre wired with 8 ft cord.



Item #	Description	Price
GEA0600	3 Bolt Blower, 60 CFM, 0.15A (18 W)	\$58.00
GEA0601	3 Bolt Blower Mounting Kit	\$17.00
GEA1480	4 Bolt Blower, 148 CFM, 0.5A (60 W)	\$72.00
GEA1481	4 Bolt Blower Mounting Kit	\$17.00

Air Jumper Tube

Air jumper tubes with twist coupling ends. Used to jump air from main inflated part to side curtains, pockets or endwalls.



Item #	Description	Price
GEA224	24" Air Jumper Tube	\$15.00
GEA248	48" Air Jumper Tube	\$16.00

Inflation Fans

Item #	Description	Price
GEA2	12VDC Muffin Fan Inflation Unit, 77 CFM, Brushless 12VDC, 0.32A (3.84 W) Includes a wirelock frame & wires with battery clamps	\$70.00
GEA20	Replacement 12V Muffin Fan Only	\$33.00
GEA20AC	110VAC Muffin Fan (25 W), wire leads only (no plug, not pre-wired). No frame, fasten with cable ties or make your own frame.	\$35.00



Greenhouse Spacer Blocks

These spacer blocks are used to create an air layer between two layers of poly without the need for an inflation blower or electricity. They are commonly used where electricity is unavailable.



Item #	Description	Price	100+
GSB	Greenhouse Spacer Block	\$5.75	\$5.50

White Felt Tape

White, 1/8" thick felt with an acrylic-based adhesive. Use to cover sharp edges or rough surfaces. Protects greenhouse hoops and components from wearing and tearing greenhouse film.

Item #	Description	Price
TAPF015	White Felt Tape, 1½" x 48'	\$18.00

White Vinyl Batten Tape

For securing plastic film to end walls, wood frame greenhouses, cold frames, etc. Just staple every 3-4" holding tape tight. 3/4" wide x 1/32" thick, 500 ft roll.

Item #	Description	Price
GGA500	3/4" x 500' Batten Tape	\$38.00

WireLock Poly Fastener

Poly fastener system that also works with shade cloth, insect and bird netting, etc. ZigZag wires lock the material in the WireLock channel. (ZigZag wire sold separately, see below). Can be used to splice poly. Can be formed to the top of curved bows. Holds up to 4 layers poly and 2 layers ZigZag wire.

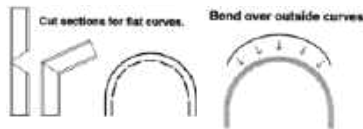

Item #	Description	Price	20+	60+
GFA1	8' Aluminum Single WireLock	\$6.30	\$5.60	\$5.20
GFA10	12' Aluminum Single WireLock	\$9.45	\$8.40	\$7.80

ZigZag Wire

For use with wirelock poly fasteners. Our ZigZag wire is made from .085" diameter, heavy duty, stainless steel spring wire, double-tempered to allow for a better return to original shape.



Item #	Description	Price	50/Bndl (200')
GFA104	4' ZigZag Wire	\$1.00	\$0.88ea=\$44.00

Double WireLock

Commonly used at the top of roll up sides which eliminates the need to run a supporting board vs single WireLock. Splice plates included. Order ZigZag wire separately.



Item #	Description	Price	8+
GFA108	8' Aluminum Double WireLock	\$15.70	\$14.30
GFA1080	12' Aluminum Double WireLock	\$23.00	\$21.00

Polycarbonate Sheeting

Clear twin-wall 8 MM polycarbonate sheeting. The perfect glazing choice for any greenhouse covering, translates its many unique features into cost saving benefits. Heavy Gauge – Increased strength. Improved hail protection. Anti-Fog – prevents condensation buildup. Improved light transmission. 10 year warranty. **Install with UV protected side toward exterior!**



Item #	Description	Price	10+
POL80408	4' x 8' Polycarbonate Sheet, 8 MM	\$40.00	\$38.40
POL80410	4' x 10' Polycarbonate Sheet, 8 MM	\$50.00	\$48.00
POL80412	4' x 12' Polycarbonate Sheet, 8 MM	\$60.00	\$57.60
POL80414	4' x 14' Polycarbonate Sheet, 8 MM	\$70.00	\$67.20
POL80416	4' x 16' Polycarbonate Sheet, 8 MM	\$80.00	\$76.80
We can custom order most any length sheets (maximum 36').			

Aluminum Extrusions for Polycarbonate

For 8 MM Polycarbonate sheeting. Double H is used to join two pieces. Single h is used to hold down edge or cover end.



Item #	Description	Price	20+
POL2H	12' Double H Extrusion	\$14.00	\$13.00
POLH	12' Single h Extrusion	\$10.75	\$10.00

Tape and Washers for Polycarbonate

POL010 is a 1" neoprene/metal bonded washer. Use with fasteners when securing polycarbonate. Aluminum tape can be used to close the top of polycarbonate. Vent tape is used to cover bottom of polycarbonate keeps bugs and dirt out while draining water and letting air in.



Item #	Description	Price
POL010	1" Metal/Neoprene Washers, 100/bag	\$10.60
POLA	2" x 150' Aluminum Foil Tape	\$11.00
POLV	1½" x 108' Vent Tape	\$31.00

End Bow WireLock

Use on gable end arch (bends to fit curved arch). Attach to top of arch with #12 x 1" Tek screws every 12" (see page 39). Cut polycarbonate to fit curve and slide underneath flange.



Item #	Description	Price	20+
GFA1212	12' End Bow Wirelock	\$17.50	\$15.50

Slide Clamps

This 3" wide pipe strap, no holes, is used for attaching double WireLock to greenhouse arches.



Item #	Description	Price
GPSC010	1¾" Slide Clamp fits 1.315" OD pipe	\$1.80
GPSC012	1⅝" Slide Clamp fits 1.66" OD pipe	\$1.80
GPSC015	2" Slide Clamp fits 1.9" OD pipe	\$1.90

Stainless Steel Screws

Tek Screws Hex head. Self drilling into metal.



Item #	Description	Bag Qty	Price	5+
GFA2107	#10 x 3/4" SS Tek Screw	100/Bag	\$9.00	\$8.00
GFA2121	#12 x 1" SS Tek Screw	100/Bag	\$10.50	\$9.50
GFA21215	#12 x 1 1/2" SS Tek Screw	100/Bag	\$14.75	\$13.50
GFA331	5/16" Hex Driver Bit for above	—	\$2.00	—
GFA2141	#14 x 1" SS Tek Screw	100/Bag	\$13.75	\$12.50
GFA337	3/8" Hex Driver Bit for above	—	\$2.50	—

Tek Screws Philips pan head. Self drilling through aluminum extrusions into wood.



Item #	Description	Box Qty	Price	5+
GFA21015	#10 x 1 1/2" Philips Tek Screw	100/Box	\$20.00	\$18.50

Wood Screws with Washer 1/4" Hex head.



Item #	Description	Bag Qty	Price	5+
GFA2015	#9 X 1 1/2" Wood Screw	250/Bag	\$36.00	\$33.00
GFA325	1/4" Hex Driver Bit for above	—	\$2.00	—

Deck Screws Star drive – no slipping. Bit included in each box.



Item #	Description	1 Lb. Box	Price	5+
SSS0915	#9 x 1 1/2" Deck Screw	167 pieces	\$20.00	\$18.50
SSS092	#9 x 2" Deck Screw	124 pieces	\$20.00	\$18.50
SSS0925	#9 x 2 1/2" Deck Screw	86 pieces	\$20.00	\$18.50

Cross Connectors

Don't Drill! Cross-Connect! Unique, 2-piece aluminum connector retains 100% of your frame's strength.



Item #	Description	Price	50+
GCC1315	Connects 1.315" to 1.315" pipe	\$2.10	\$1.85
GCC166	Connects 1.315" to 1.66" pipe	\$2.15	\$1.90
GCC200	Connects 1.315" to 1.9" pipe	\$2.20	\$1.95

Metal Pipe Straps

These heavy-duty, 3 hole metal pipe straps are used to fasten purlins, windbraces, baseboards, etc. Has a predrilled hole on the round part of the strap for a third tek screw to keep it from sliding.



Item #	Description	Price	300+
GPS010	1-3/8" Pipe Strap, fits 1.315" OD pipe	\$0.55	\$0.45
GPS012	1-5/8" Pipe Strap, fits 1.66" OD pipe	\$0.68	\$0.58
GPS015	1.9" Pipe Strap, fits 1.9" OD pipe	\$0.70	\$0.60
GPS020	2-3/8" Pipe Strap, fits 2.375" OD pipe	\$0.85	\$0.75

Black Nylon Cable Ties, UV Treated

Item #	Length	Tensile Strength	Max Bundle Dia.	Bag Qty	Price
BCT05	5"	40 Lbs.	1.25"	100/Bag	\$4.00
BCT08	8"	40 Lbs.	2"	100/Bag	\$4.50
BCT11	11"	50 Lbs.	3"	100/Bag	\$6.00
BCT14	14"	120 Lbs.	4"	100/Bag	\$10.00

Square Galvanized Tubing

This steel square tubing has a heavy-duty galvanized coating for long term rust and corrosion protection. Uses include: framing greenhouse gable ends, greenhouse benches, doors, etc.



Item #	Description	Price	25+
GGPS1713314	1.75" x 13' 4" long, 14 Gauge	\$31.00	\$29.00
GGPS152416	1.5" x 24' long, 16 Gauge	\$37.00	\$35.00

Splicer for Square Tubing

Fits inside square tubing. Secure with tek screws.

Item #	Description	Price
GGPSC17	Splicer for 1.75" Square Tubing, 1.5 x 8"	\$2.80
GGPSC15	Splicer for 1.5" Square Tubing, 1.25 x 12"	\$2.80

Metal End Wall Angle

Ell for connecting square tubing at right angles. Angle is 1 1/2" x 2" with three holes for fasteners. Fasten with #14 x 1" Tek screws.

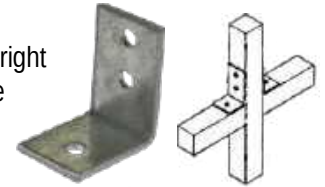

Item #	Description	Price	100+
GGPA	Metal End Wall Angle	\$0.55	\$0.45

Brace Bands

Item #	Description	Price
GFA31315	1.315" Brace Band	\$0.62
GFA3166	1.66" Brace Band	\$0.65
GFA3200	1.9" Brace Band	\$0.70
GN 1	5/16" Galv. Nut	\$0.08
GCB015	5/16" x 1-1/2" Galv. Carriage Bolt	\$0.24



End Wall Framing Brackets

Used to attach end wall framing to the gable end arch. Works with any wood or metal square tubing end walls. Size indicates size of brace band, match to your arch size.



Item #	Description	Price
GFA241315	1.315" End Wall Framing Bracket	\$3.35
GFA24166	1.66" End Wall Framing Bracket	\$3.45
GFA24200	1.9" End Wall Framing Bracket	\$3.50

Extension Hangers

Heavy-duty S-hooks

Made from 10 gauge galvanized steel, these S-hooks can hold up to 35 pounds. 1 3/8" hooks on each end.

Item #	Description	Price
S 06	6" S-hooks, 100/Box	\$24.50
S 12	12" S-hooks, 100/Box	\$29.00
S 15	15" S-hooks, 100/Box	\$32.50
S 18	18" S-hooks, 100/Box	\$36.00
S 24	24" S-hooks, 100/Box	\$41.00
S 30	30" S-hooks, 100/Box	\$49.00
S 36	36" S-hooks, 100/Box	\$51.00

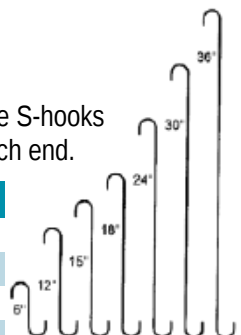

Greenhouse Roll Up Sides

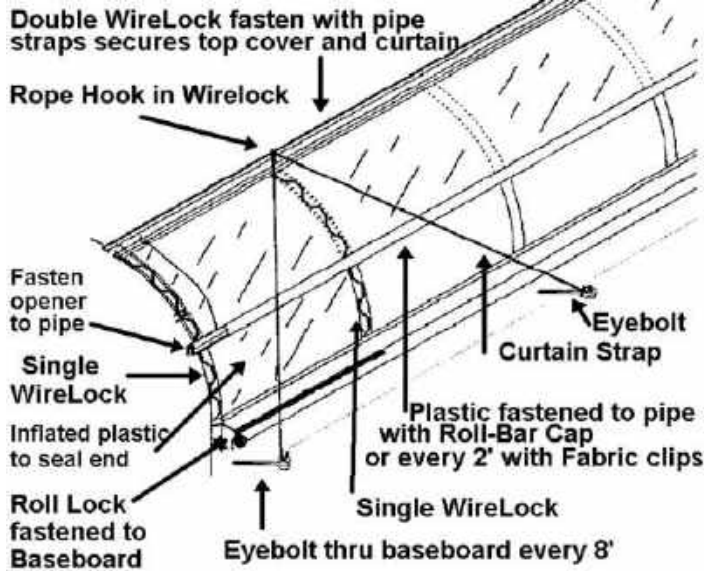

Double WireLock & ZigZag Wire (see page 38.)

1.315" Galvanized Swedged Pipe, 17 ga.

For purlins or roll up pipe. With 3" length swedge.

Item #	Description	Price	10+
GGP131217S	1.315" Purlin, 12' plus swedge	\$12.65	\$12.00
GGP130817S	1.315" Purlin, 8' plus swedge	\$9.50	\$9.00

Roll Bar Cap

Securely holds single or double layer plastic to 1.315" OD. roll pipe. Fasten with #12 x 1" Tek screws every 12"

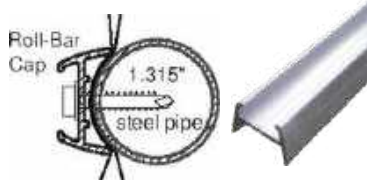

Item #	Description	Price	24+
GFA5RBC	8' Roll Bar Cap	\$6.25	\$5.60

Aluminum Fabric Clips

Fastening plastic or shade cloth to pipe is a snap with fabric clips. Space every 2' on roll pipe.



Item #	Description	Price	100+
FC 007	3/4" Fabric Clip, fits 0.92" OD pipe	\$1.25	\$1.20
FC 010	1" Fabric Clip, fits 1.315" OD pipe	\$0.80	\$0.75
FC 012	1 1/4" Fabric Clip, fits 1.66" OD pipe	\$1.00	\$0.95

Side Clasp Roll Bar

2" OD "all-in-one" roll bar. This roll bar can be used on curtain systems up to 200'. Works great with Roll-Lock. The SCRB uses Zig-Zag Wire (not included) to clasp one or two layers of curtain material into the built-in WireLock groove, allowing it to maintain its round shape as it rolls up. Comes with square splicer that keeps roll bar from twisting.



Item #	Description	Price	8+
GFA5SCRB12	12' Side-Clasp Roll Bar	\$33.25	\$32.00

Aluminum Roll-Lock

The Posi-Clasp Roll-Lock extrusion, creates a fully secured seal at the bottom of the roll up sides. Because of its superior seal it is recommended to use on heated structures. Enhances wind control and extends poly life. Splice plates are included.

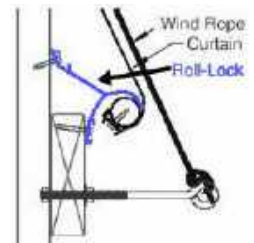

Item #	Description	Price	6+
GFA5RL	8' Aluminum Roll-Lock	\$32.00	\$31.00
GFA5RL1	12' Aluminum Roll-Lock	\$48.00	\$46.50

Roll Pipe Installation Aids

Hangers (RPHRL & RPH2x) make roll bar installation quicker, easier & more uniform. Pipe hanger sets uniformly support 96' feet of roll pipe during installation. Hangers can be moved along greenhouse as installation progresses. Roll pipe deflector is for 2" baseboard. Install when not using Roll-Lock to deflect roll pipe out over edge of baseboard.

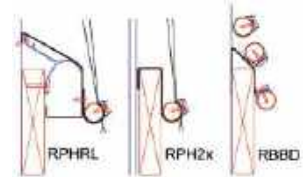

Item #	Description	Price
GFA5RPHRL	1.315" Pipe Hanger, for Roll-Lock, set of 9	\$39.00
GFA5SCHRL	Side Clasp Hanger, for Roll-Lock, set of 9	\$39.00
GFA5RBBD	Pipe Deflector, for 2" baseboard, set of 9	\$19.00
GFA5RPH2X	Roll Pipe Hanger, fits 2" baseboard, set of 9	\$19.00

Zinc Eye Bolts & Screws

Item #	Description	Price
ZEB04003	5/16" x 4" Eye Bolt, for baseboard w/o Roll-Lock	\$1.15
ZEB08004	3/8" x 8" Eye Bolt, for baseboard w/ Roll-Lock	\$1.65
ZES04003	5/16" x 4" Eye Screw, for baseboard w/o Roll-Lock	\$0.85

Curtain Rope & Rope Hooks

Black Braided Curtain Rope, 1/4", 100% polyester. Aluminum Rope Hook inserts into WireLock without fasteners. Open hook for 1/4" rope.



GFA5RH

Item #	Description	Price
GFA5CR	1/4" x 350' Black Curtain Rope	\$39.00
GFA5RH	Aluminum Rope Hook, Pack of 25	\$25.00

Curtain Strapping

Item #	Description	Price
GFA5CS2	2" x 600' Black Curtain Strapping, UV resistant	\$48.00

Handheld Poly Sealer

Seal 2 layers of poly together at curtain ends to allow roll up sides to inflate. Required for automatic inflation of Roll Up/Lockdown Systems that use the Roll-Lock extrusion. Features: 6" sealing length with teflon coated jaws. Seals PE, PVC, Cello, Mylar, and more. 115 volt, 25 watt



Item #	Description	Price
GFA5HS	Handheld Poly Sealer, 6" jaws	\$109.00



Manual Gear Crank Operator Packages

5:1 Ratio, internal brake. Needs to be reached from the ground. Uses 1" OD guidepipe. Rolls up to 96'. Not for use with Roll-Lock (use HD cranks, see below).



Item #	Description	Price
GFAM04	5:1 Gear Crank, fits 1.315" roll pipe	\$84.00
GFAM04P	6' Guidepipe & Hanging Hardware for GFAM04	\$16.00

7:1 Ratio, Heavy-duty, internal brake. Includes 24" crank handle. Rolls up to 120', works with Roll-Lock. Fits 1.315" guidepipe and roll pipe.



GFAM07

13:1 Ratio, Heavy-duty, internal brake. Includes 24" crank handle. Rolls up to 240', works with Roll-Lock. Fits 1.315" guidepipe and roll pipe.



GFAM13

GFAMLH



GFAMDC14



Item #	Description	Price
GFAM07	7:1 Gear Crank with 24" crank handle	\$152.00
GFAM13	13:1 Gear Crank with 24" crank handle	\$185.00
Upon request: Longer handles for above cranks, 4, 6, 8 & 10 ft.		
GFAMDC14	14" Drill Crank (For GFAM07 & GFAM13)	\$23.50
GFAMLH	Loop Handle (For GFAM07 & GFAM13)	\$37.00

Steel Swivel Lock & Hand Crank

Simple roll up crank. Includes locking universal joint and hand crank. Use 1.315" pipe to connect the pieces (not included). Pipe should be long enough so that handle locks against the ground. Only recommended for rollup sides or doors that are 36' or shorter.



Item #	Description	Price
GFASHC	Hand Crank & Swivel Lock	\$30.00

Manual Gear Crank for Doors

Doesn't require a guide pipe and allows the roll pipe to touch the ground. Ideal for doors or curtains that don't reach to the end of the structure. Stays attached to the roll pipe and is held at the correct height by securing handle to sidewall. 7:1 ratio with internal brake. Fits 1.315" roll pipe. 1.66" adapters also available.



Item #	Description	Price
GFAM07LH4	7:1 Gear Crank with 4' long handle	\$200.00

Low Voltage Controllers

For ventilation control on roll up sides and roof vents with low voltage motor packages. 110VAC input, 24VDC output. Also controls heaters & fans. All controllers have manual override.

Tired of using multiple thermostats? We sell custom touch-screen controllers to control all the ventilation and heat in your greenhouse(s). For quote, call with your requirements.



GFA5VCU2



GFA5VC40

Item #	Description	Price
GFA5VCU2	Controller; 1 stage of rollups (1 or 2 motors) + 2 stages dry contacts for heaters, fans, etc.	\$780.00
GFA5VC40	AegisTEC Touchscreen Controller; 2 stages of rollups (3 motors) + 2 stages contacts for heaters, fans, etc. With timed, weather, & humidity override options. Sensors sold separately.	\$1050.00
GFA5VC40-Plus	AegisTEC-Plus Touchscreen Controller; Same as above except more capacity. Dual zone capable (2 nd sensor needed).	\$1550.00
GFA5CIB	Contactors to run fans, max 25 amps	\$116.00
GFA5VCSH	Humidity Sensor, override for all above	\$465.00
GFA5VCSR	Rain Sensor, override for AegisTEC	\$315.00
GFA5VCSW	Anemometer, Wind override for AegisT	\$245.00

Also available: Solar powered controllers and interface boxes to accept signals from other controllers. **Call for prices.**

Low Voltage Curtain Motor

Energy efficient yet powerful! 24VDC motors for above controllers. Rolls up to 5 x 200 curtain. Includes roller guide, adapter for 1.315" roll pipe and guidepipe hardware. Use 1.315" guidepipe.



Item #	Description	Price
GFA5LVM60	60NM, rolls up to 5' x 200' curtain	\$308.00
GFA5LVML	Limit Switch, required if using with Roll-Lock	\$95.00

Solarside® Woven Curtain Poly

Great for rollup curtains, rollup doors or gable end covering.

- More puncture resistant than 6mil poly.
- Lightweight and extremely strong
- Diffuses light evenly
- UV Stabilized
- 87% Light transmission
- 4.7 oz/sq. yd. (160 GSM)



Priced and sold by the linear foot.

Item #	Description	1'-99'	100'-199'	200'+
FRS06	6' Solarside Reinforced Poly	\$1.85	\$1.74	\$1.65
FRS13	13' Solarside Reinforced Poly	\$3.59	\$3.37	\$3.20



Greenhouse Doors

Greenhouse doors, ready to install. High quality aluminum construction with two polycarbonate windows.

Optional: Tempered glass for top window.

Allow 6-10 weeks lead time.

Except sizes marked with #, which we try to keep in stock.

Single Sliding: Optional – add \$18.00 for Bottom Seal Brush

All Polycarbonate		With Temp. Glass Top Half	
DSS 200 3' x 7'	\$565.00	DSSGT200 3' x 7'	\$595.00
DSS 201 3' x 8'	\$610.00	DSSGT201 3' x 8'	\$625.00
DSS 202 4' x 7' #	\$595.00	DSSGT202 4' x 7'	\$630.00
DSS 203 4' x 8' #	\$628.00	DSSGT203 4' x 8'	\$685.00

Includes: Standard Latch, Brushes (two sides & top), Aluminum Track & Rollers, 2 Pull Handles, 1 Stay Roller, and 1 Door Guide

Double Sliding: Optional – add \$36.00 for Bottom Seal Brush

All Polycarbonate		With Temp. Glass Top Half	
DDS 250 3' x 7'	\$888.00	DDSGT250 3' x 7'	\$920.00
DDS 251 3' x 8'	\$945.00	DDSGT251 3' x 8'	\$985.00
DDS 252 4' x 7' #	\$935.00	DDSGT252 4' x 7'	\$1015.00
DDS 253 4' x 8' #	\$1008.00	DDSGT253 4' x 8'	\$1090.00

Includes: Standard Latch, Brushes (two sides & top), Aluminum Track and Rollers, 4 Pull Handles, 2 Stay Rollers, 1 Cane Bolt, 1 Door Stay and Fasteners.

Single Hung

All Polycarbonate		With Temp. Glass Top Half	
DSH 100 3' x 7' #	\$575.00	DSHGT100 3' x 7' #	\$605.00
DSH 101 3' x 8'	\$620.00	DSHGT101 3' x 8'	\$660.00
DSH 102 4' x 7' #	\$615.00	DSHGT102 4' x 7'	\$655.00
DSH 103 4' x 8'	\$660.00	DSHGT103 4' x 8'	\$730.00

Includes: Commercial Lever Latch, 1 Door Stop, 1 Bottom Sweep & Fasteners. **Outswing with hinges on left (outside).**



Pictured: 3' x 7' Double Hung (view from inside of the door)

Double Hung

All Polycarbonate		With Temp. Glass Top Half	
DDH 150 3' x 7'	\$935.00	DDHGT150 3' x 7' #	\$1020.00
DDH 151 3' x 8'	\$990.00	DDHGT151 3' x 8'	\$1085.00
DDH 152 4' x 7'	\$995.00	DDHGT152 4' x 7'	\$1045.00
DDH 153 4' x 8'	\$1060.00	DDHGT153 4' x 8'	\$1225.00

Includes: Commercial Lever Latch, 2 Door Stops, 2 Bottom Sweeps, 1 Pull Chain, 1 Cane Bolt Fasteners and Center Astragal. **Main door is Outswing with hinges on left (outside).**

Basic Roll-up Doors for High Tunnels

We can quote based on the size needed. Up to 9'x23' for our 30' structures. Maximum recommended height is 10 ft.

Use: 4.7 oz woven curtain poly, single wirelock across the top, 2 runs (center and bottom) of 1.6" galvanized pipe with roll-bar cap and a low wall gear crank. Or 1.315" galvanized pipe for doors at 11' or less in width.

Pictured: Basic roll-up door with swivel lock and hand crank and regular 6 mil plastic.



DBCI Corrugated Metal Roll-up Doors

26-gauge galvanized, polar white, grade E hard steel curtain with 5/8" ribbed corrugation. All models listed below are wind rated at 90 plus MPH. Unlike most other brands these doors have corrugated drum to prevent misalignment and for quieter operation. 9-1/2 drum diameter.

For more info visit www.dbci.com.



Corrugated Drum

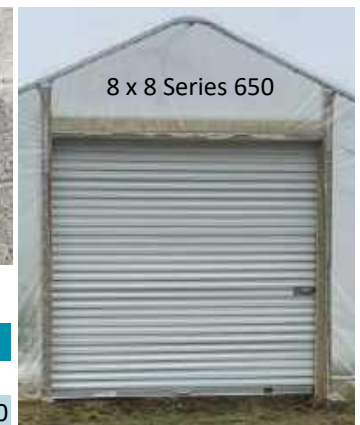

Item #	Description	Price
MRD0808	8' wide x 8' high, Series 650, 18-gauge galv steel guide system, no chain hoist	\$875.00
MRD1009	10' wide x 9' high, Series 690, 16ga galv steel guides & windbar, no chain hoist	\$1220.00



Aluminum Shutters



These aluminum shutters from Hessaire are designed to be used as an inlet, but may also be used for free-air exhaust. Constructed of heavy gauge aluminum with galvanized steel reinforced corners.

Item #	Description	Price
JAS16	16" Single Panel Shutter	\$48.00
JAS24	24" Single Panel Shutter	\$75.00
JAS30	30" Single Panel Shutter	\$94.00
JAS36	36" Double Panel Shutter	\$152.00
JAS40	40" Double Panel Shutter	\$175.00
JAS42	42" Double Panel Shutter	\$195.00
JAS48	48" Double Panel Shutter	\$213.00
JAS54	54" Double Panel Shutter	\$250.00
JAS60	60" Double Panel Shutter	\$300.00



For rough opening: add 1/2" to shutter size (both dimensions).

Heavy-Duty ACME Shutters		
JAS36H	36" Single Panel Shutter	\$205.00
JAS48H	48" Double Panel Shutter	\$355.00

Shutter Motor Kits

Works with all the above shutters. 115/230V. Includes: motor, lever arm, chain, s-hooks, tension springs, mounting bracket and assembly hardware.



Item #	Description	Price
JAS1	Shutter Motor Kit	\$99.00

Univent Automatic Opener

Can be adjusted to open at between 60°– 70°F. Fully open at 86°F. Works on 30" & smaller aluminum shutters (see above). Lifts up to 33 lbs.



Item #	Description	Price
JAS1A	Univent Automatic Opener	\$45.50
JAS1AH	Hardware to mount to above shutters	\$2.50

Shutter & Slantwall Fans



JSF Shutter Fan, *shown above left*: features heavy-duty combination motor mounted/safety guard with bright easy-to-clean zinc-chromate finish.
 JSW Slantwall Fan, *shown above right*: features galvanized box, Direct drive motors, except JSW36 and JSW50C are belt drive, wire mesh guard. JSW50C features cone for better performance.

Item #	Size	CFM	HP/RPM	Rough Opening	Price
JSF12	12"	970	1/10 hp/1,625	12-5/8"	\$198.00
JSF16	16"	1,440	1/10 hp/1,625	16-5/8"	\$201.00
JSF20	20"	3,140	1/3 hp/1,725	20-5/8"	\$264.00
JSF24	24"	4,640	1/2 hp/1,725	24-5/8"	\$328.00
JSF30	30"	6,770	1/2 hp/825	30-5/8"	\$402.00
JSW30	30"	7,100	1/2 hp/825	38"H x 37"	\$660.00
JSW36	36"	9,700	1/2 hp belt drive/525	42"H x 41"	\$1150.00
JSW50C	50"	21,600	1 hp belt drive/588	57"H x 55"	\$1390.00

Circulation Fans



With 10' cord, pre-wired for 115 volts, single phase. Totally enclosed, maintenance-free, direct drive high-efficiency motors have completely sealed ball bearings. Motors are variable speed capable (controller not included).

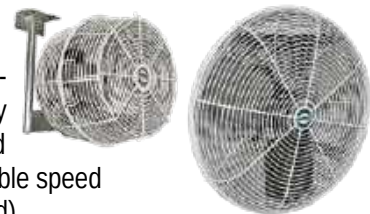

Item #	Description	Price	4+
JHF2	20" EZ-Breeze Fan, 1,680 CFM 1/10 hp, 1.42 amps	\$144.00	\$140.00
JHF12 and JHF20: Front can be opened for cleaning.			
JHF12	12" Green Breeze Fan, 970 CFM 1/10 hp, 1.42 amps	\$154.00	\$150.00
JHF20	20" Green Breeze Fan, 3,650 CFM 1/3 hp, 3.8 amps	\$245.00	\$239.00

Circulation Fan



This 12" Hessaire circulation fan features industrial grade aluminum blades. Guards are powder coated. Bracket included. Single phase, 115V, 1.0A, 1/10 hp motor. 1,085 CFM



Item #	Description	Price	4+
JHF12H	12" Hessaire Circulation Fan	\$99.00	\$96.00

Euroemme Heavy-Duty Exhaust Fans

Centrifugal shutter system keeps the efficiency of the fan at peak all the time by keeping the shutters fully open. Shutters do not have to be cleaned regularly. Heavy duty galvanized shutters are tightly closed when the fan is not in operation, preventing any air leakage. Considering the effect of dirty shutters on the other slant wall fans, the efficiency of the Euroemme fan is 15-25% better than any other fan.



Item #	Size	CFM @ 0" Static Pres.	Motor	Rough Opening	Price
EF 136	36"	11,650	3/4 hp	43"	\$1195.00
EF 150	50"	20,500	1 hp	54 1/2"	\$1390.00

A complete ventilation system is essential for all greenhouse applications.

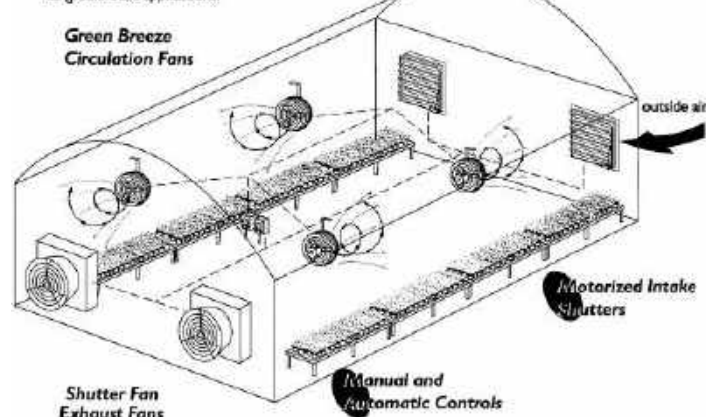

Modine Gas-Fired Unit Heaters

When ordering please specify
Propane or Natural Gas



Modine Model PTP

Stainless Steel Heat Exchangers for longer life. 82% Efficiency. Modine's horizontal power vented PTP unit heater line. Electronic Ignition with 100% shutoff and continuous retry. Power vent does not require vertical vent pipe.



Item #	BTU/hr Input/Output	CFM	Vent Size	Weight	Price
MPPT150*	150,000/123,000	2,140	4"	165 Lbs	\$1,460.00
MPPT175*	175,000/143,500	2,725	4"	210 Lbs	\$1,630.00
MPPT200*	200,000/164,000	2,870	4"	220 Lbs	\$1,710.00
MPPT250*	250,000/205,000	3,995	6"	265 Lbs	\$2,070.00
MPPT300	300,000/246,000	4,545	6"	270 Lbs	\$2,430.00

Modine Model PDP

83% Efficiency. Modine's vertical power vented PDP unit heater line. Electronic ignition with 100% shutoff and continuous retry. Power vent does not require vertical vent pipe.



Item #	BTU/hr Input/Output	CFM	Vent Size	Weight	Price
MPDP150	150,000/124,500	2,180	5"	168 Lbs	\$1,460.00
MPDP175	175,000/145,250	2,550	5"	175 Lbs	\$1,630.00
MPDP200	200,000/166,000	2,870	5"	239 Lbs	\$1,710.00
MPDP250	250,000/207,500	3,700	6"	239 Lbs	\$2,070.00

All Modine heaters are for LP gas (propane) unless otherwise specified. ITEM #'s MARKED * ARE ALSO STOCKED FOR NATURAL GAS. Specify when ordering by adding "N" to the item #'s (e.g. MPPTN150) We can also order other models for natural gas (4-6 weeks leadtime)

Modine also has: Larger gas-fired units, Steam/Hot water units, Conversion Kits, Optional SS burners or heat exchangers for the PDP's. Call for pricing and more info on all special order items.

Thermostats

GEA801



These corrosive environment thermostats can be wired for heating or cooling. Up to 240Vac. SS sensor. Temperature range: 40°-100°F.

Item #	Description	Price
GEA801	Single Stage Thermostat	\$32.00
GEA82	2 Stage Peco Thermostat	\$88.00
GFA5ATEC-AC	Aegistec touch-screen controller with 8 dry contacts for 110/220vac fans or shutters. Also control up to 4 heaters.	\$1268.00

[Pictured on page 41](#)

NEW FOR 2024

Twister Exhaust Fan

For Convection Tubing (will reduce CFM) Galvanized Exhaust/Tube Fan, has center hinged galvanized butterfly shutter that can easily be removed for tube applications.



Item #	Description	Price
JET24	24" Fan, 4820 CFM, 1/2 hp motor	\$415.00

Modine Efficiency⁹³

Modine Model PTC. With Stainless Steel Heat Exchangers for longer life.



At 93% efficiency, Modine's Efficiency⁹³ is the most efficient condensing unit heater in North America. Direct Spark Ignition. Power Exhaust. High Efficiency Separated Combustion. Use PVC Vent pipe, use same size pipe for combustion air inlet. (Do not draw combustion air out of greenhouse.) Drains an acidic condensate. Vent and drain must be installed properly.

Item #	BTU/hr Input/Output	CFM	Vent Size	Weight	Price
MPTC085	85,000/79,050	1,650	3"	125 Lbs	\$2,550.00
MPTC135	135,000/125,550	2,160	3"	165 Lbs	\$3,950.00
MPTC180	180,000/167,400	3,020	4"	215 Lbs	\$4,230.00
MPTC215	215,000/199,950	3,865	4"	265 Lbs	\$4,600.00
MPTC260	260,000/241,800	4,585	4"	265 Lbs	\$4,950.00

Modine Hot Dawg[®]

Electronic Ignition with 100% shutoff and continuous retry. Power vent does not require vertical vent. 82% Efficiency.



Item #	BTU/hr Input/Output	CFM	Vent Size	Weight	Price
MHD045*	45,000/36,900	720	3"	60 Lbs	\$825.00
MHD075*	75,000/61,500	1,160	3"	85 Lbs	\$965.00
MHD100*	100,000/82,000	1,490	4"	125 Lbs	\$1110.00
MHD125*	125,000/102,500	1,980	4"	128 Lbs	\$1195.00

Convection Tubing



Kenbar convection tubing is made from clear polyethylene and is protected with a strong ultraviolet inhibitor. The plastic is formulated for maximum light penetration and for durability in a greenhouse environment.

Convection Tubing Punch Positions

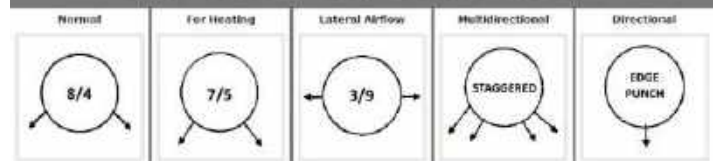

We will ship standard 8/4 punch unless otherwise specified. For staggered or edge punch add \$0.12/ft.

Item #	Description	Price
GCT612	12" Dia. Tubing, 6 mil 3 year	\$0.90/ft
GCT618	18" Dia. Tubing, 6 mil 3 year	\$1.15/ft
GCT624	24" Dia. Tubing, 6 mil 3 year	\$1.45/ft
GCT630	30" Dia. Tubing, 6 mil 3 year	\$1.75/ft

Small Order Upcharge of \$13 on orders less than \$50. Shipped from and FOB, Rochester, NY.



Thermalarm II

Metal contacts close this normally open switch when temperatures exceed the limits you set. Temperature range: 20°–110°F. No magnetic switch, no relay needed. 6–12 volts.



Item #	Description	Price
GEA300	Thermalarm II	\$45.50

Prewired Temperature Alert

Low and high temperature alert. This sensor, made from a pair of our single stage mechanical thermostats, features superior accuracy and reliability, and will be less likely to corrode or stick than a Thermalarm. Set your desired temperature limits between 40° and 110°F. Labeled, easy to test, no relay needed, wired for up to 24 volts. Prewired with 6' wire to battery and 60' to siren. *Battery and siren not included.*



Item #	Description	Price
SEN2	Prewired Temperature Alert	\$99.00

Sirens



GEA301



GEA302



BAT12V

Item #	Description	Price
GEA301	Outdoor Siren, Dual Tone, 115 dB, 6–12 VDC	\$23.00
GEA302	Indoor Siren with strobe, 110 dB, 6–12 VDC	\$18.50
BAT12V	12V Lantern Battery, thumb screw terminals	\$18.50

EasyAlert Wireless Alarm System

This wireless alarm system is an advanced monitoring system that allows you to connect up to 16 wireless sensors, plus hardwired sensors. Wireless sensors have a range of up to 1 mile (line of sight), making this the ideal alarm system to monitor your property without running wires to every structure. With battery backup, the alarm will continue to monitor during a power failure.

Customizable: This system isn't limited to temperature monitoring.

Wireless Alarm System Base: Packaged with 110VAC charger and 1 temperature sensor, pre-programmed and ready to use. Enclosed in a plastic case with a speaker that produces a sharp chime when a transmitter is triggered. Adjustable volume. Can be programmed to produce a unique chime for each transmitter. If you put the base in your house, these chimes can wake you up. Or in an outbuilding we recommend you connect it to an outdoor siren. It has a **built-in power failure & low battery alarm**. Programming is done in the base, eliminating the need for a computer.

Hi/Lo Temperature Sensor monitors air temperatures. High and low temperature set points can be set between 40° and 110°F. Wireless, uses 4 AA batteries. Sensor is a pair of weatherproof thermostats with a built in transmitter. By using these mechanical thermostats it makes for a very reliable easy to use transmitter.

Sensaphone®

Remote Monitoring. Protect your investment even when you can't be there. Monitors your unattended facility to detect power failures, temperature extremes, intrusions, water incursion, sounds such as smoke and burglar alarms, and other conditions of your choice.



Alerts you immediately if problems arise. In case of alarm automatically contacts you by phone at up to four (Sensaphone 400) or eight (Sensaphone 800) different phone numbers.

The system communicates in voice synthesized English. Call in any time from any phone for status reports which include power status, temperature, zone status, and also lets you listen to actual sounds onsite.

Includes built-in sensors to monitor a variety of conditions: High sound level; AC electric power failure; Battery backup; Temperature (uses 1 input). Configurable inputs work with temperature sensors and normally open & normally closed switch type sensors. If you use SEN2 Prewired Temperature Alert or GEA300 Thermalarm II you can parallel wire multiple units to one input.

Works on regular phone lines and/or on fax lines. Will not interfere with operation of answering machine and will not answer except selectively. Fully and easily programmable.

Item #	Description	Price
SEN400	Sensaphone 400, 4 configurable inputs, dials up to 4 phone numbers	\$440.00
SEN800	Sensaphone 800, 8 configurable inputs, dials up to 8 phone numbers	\$640.00
SEN101	Weatherproof Temperature Sensor, 12' Wire	\$36.00



WA1710 Transmitter



WA1714
Solar
Panel



WA1700 Alarm Base

Item #	Description	Price
WA1700	Alarm Base & 1 Hi/Lo Temperature Sensor	\$620.00
WA1710	Additional Hi/Lo Temperature Sensor	\$228.00
WA1714	Optional Solar Panel 12VDC Battery Charger	\$62.50
WA1716	Voice Dialer, Custom add on for base	\$192.00

Can be used with sirens (above) or with other 12V alarms.

Custom Options: Solar Panel recommended when 110VAC isn't available. Voice Dialer—calls up to 5 phone numbers when alarm is triggered. We can customize. Call us with any questions.



STOCK Greenhouse Frames

Manufactured in Dundee OH, all the greenhouse and high tunnel frames on this page and page 47 feature triple galvanized tubing for years of service. Call for pricing on any length frames, custom arch spacing, higher side walls and crossties, or rack & pinion roof vent. See page 48 or contact us for a detailed quote on a complete greenhouse or high tunnel package customized to your needs.

Prices subject to change without notice. Call to request a quote or check availability.

21' Peaked Greenhouse, 5' Straight Sides

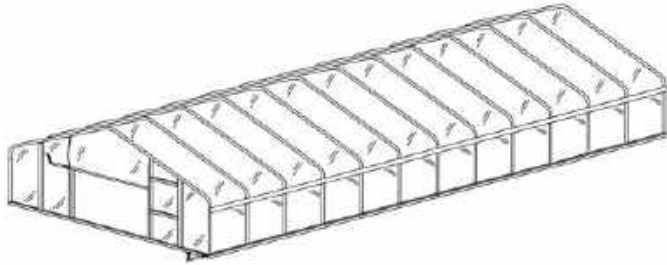

This 21' frame is 10½' to peak and has 3 purlins and 4 wind braces. Hardware includes: cross connectors and pipe straps for fastening purlins, pipe straps and bolts for baseboard, end wall brackets assembly instructions and stake driver. Uses 35' wide plastic cover. Optional Crossties 1.315" x 14ga w/1 upright brace.

Size	Price	Optional 7' High Crossties add:
21' x 24'	\$1,180.00	\$175.00
21' x 48'	\$2,020.00	\$385.00
21' x 72'	\$2,840.00	\$590.00
21' x 96'	\$3,650.00	\$795.00

12' & 16' Quonset Greenhouses

Both 12' & 16' have 3 purlins and 4 wind braces. Includes pipe straps for fastening purlins, pipe straps and bolts for baseboard, end wall brackets assembly instructions and stake driver.

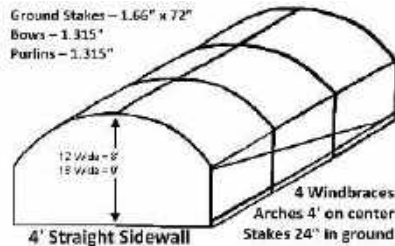

Length	12' Wide	16' Wide
24'	\$775.00	\$935.00
48'	\$1,365.00	\$1,640.00
72'	\$1,900.00	\$2,300.00
96'	\$2,400.00	\$2,900.00

12' uses 24' wide plastic cover.
16' uses 28' wide plastic cover.

20' Cold Frame (No snow load claim.)

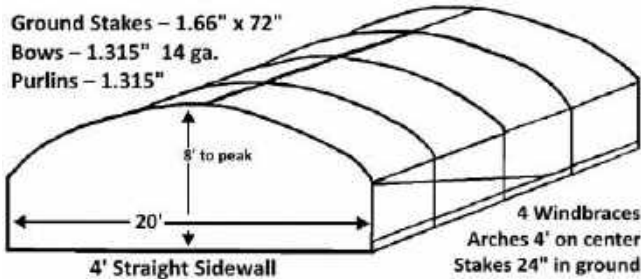

This 20' frame has 3 purlins and 4 wind braces. Also includes pipe straps, end wall brackets, bolts & screws, and stake driver. Uses 32' wide plastic cover.

Size	Price	Size	Price
20' x 24'	\$990.00	20' x 48'	\$1,730.00
20' x 72'	\$2,450.00	20' x 96'	\$3,125.00

24' Gothic Greenhouse, 4' Straight Sides

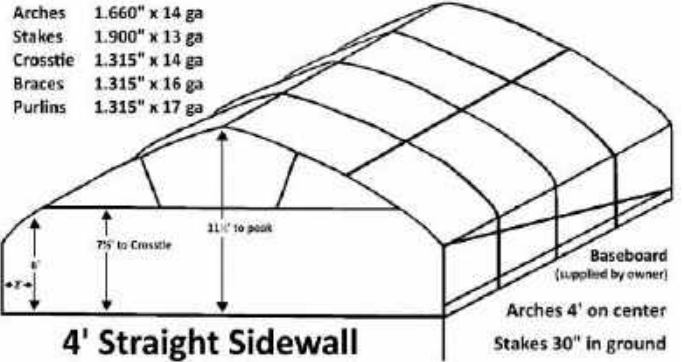

Arches 1.660" x 14 ga
Stakes 1.900" x 13 ga
Crosstie 1.315" x 14 ga
Braces 1.315" x 16 ga
Purlins 1.315" x 17 ga

This 24' frame has crosstie assembly on each arch except end arches, 3 purlins and 4 wind braces. Hardware includes: heavy duty cross connectors and pipe straps for fastening purlins, pipe straps for baseboard, end wall brackets, assembly instructions and stake driver. Uses 39' wide plastic cover.

Size	Price	Optional 5½' Sidewall add:
24' x 48'	\$2,800.00	\$78.00
24' x 72'	\$4,000.00	\$114.00
24' x 96'	\$5,200.00	\$150.00

Individual Frame Components

Item #	Description	Price
C12B	12' wide, 1 piece Bow, 1.315" 16 ga	\$43.00
C16B	16' wide, 1 piece Bow, 1.315" 14 ga	\$62.00
C20B	20' wide, 1 piece Bow, 1.315" 14 ga	\$72.00
C21B	21' wide, 1 piece Bow, 1.66" 14 ga	\$86.00
C20P	72" Ground Stake, 1.66" 13 ga	\$17.50
C21P	78" Ground Stake, 1.90" 13 ga	\$19.50
C21P8	96" Ground Stake, 1.90" 13 ga	\$24.00
GFR0	Ground Stake Driving Head, for 1.66"	\$11.00
GFR01	Large Ground Stake Driving Head, for 1.9"	\$15.00

Galvanized Purlins/Pipe



Item #	Description	Price	Qty	Price
GGP091018	0.922" x 10' Purlin, swaged, 18 gauge. Put on top of crossties for hanging baskets	1-24	25+	\$9.00 \$8.25
GGP131217S	1⅜" x 12' 3" Purlin, swaged, 17 gauge For roll-up pipe, purlins, etc	1-9	10+	\$12.65 \$12.00
GGP162413	1.66" x 24' Purlin, 3" swage, 13 gauge, For ground stakes or HD purlin	Per ft:	Full 24' pc	\$2.00 \$37.20
GGP192413	1.9" x 24' Purlin, 13 gauge, no swage. For ground stakes	Per ft:	Full 24' pc	\$2.60 \$50.40

30' Standard Gothic Greenhouse

Arches 1.660" x 14 ga
Stakes 1.900" x 13 ga
Crosstie 1.315" x 14 ga
Braces 1.315" x 16 ga
Purlins 1.315" x 17 ga

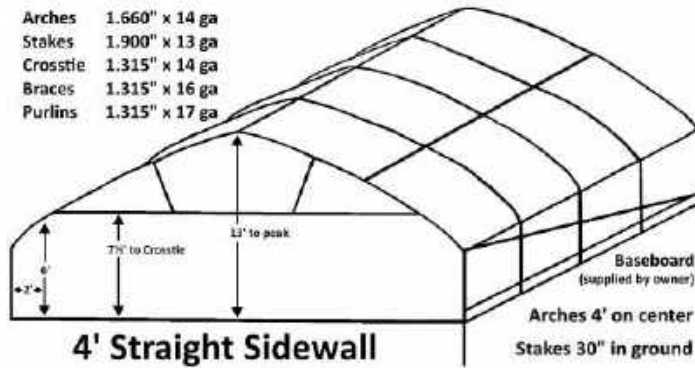

This 30' frame has crosstie assembly on each arch except end arches, 5 purlins and 4 wind braces. Hardware includes: heavy duty cross connectors and pipe straps for fastening purlins, pipe straps for baseboard, end wall brackets, assembly instructions and stake driver. Uses 46' wide plastic cover.

Size	Price	Optional 5½' Sidewall add:
30' x 48'	\$3,370.00	\$78.00
30' x 72'	\$4,830.00	\$114.00
30' x 96'	\$6,250.00	\$150.00
30' x 144'	\$9,175.00	\$222.00

Optional Rack & Pinion Roof Vent

A roof vent is the most efficient natural ventilation when combined with roll up sides. Recommended to use with automated controller and low voltage motors. But also available with chain wheel for manual operation. Can be added to any of our 24', 30' & 34' structures. Call for more information or pricing.

NON-STOCK Greenhouse Frames, 6' arch spacing

These frames feature 2¾" arches and 6' arch spacing. Contact us for pricing on custom length, etc. Lead time is 3-6 weeks from Iowa. Prices subject to change without notice. Call to request a quote or check availability.

30' Gothic Greenhouse, 5' Straight Sides

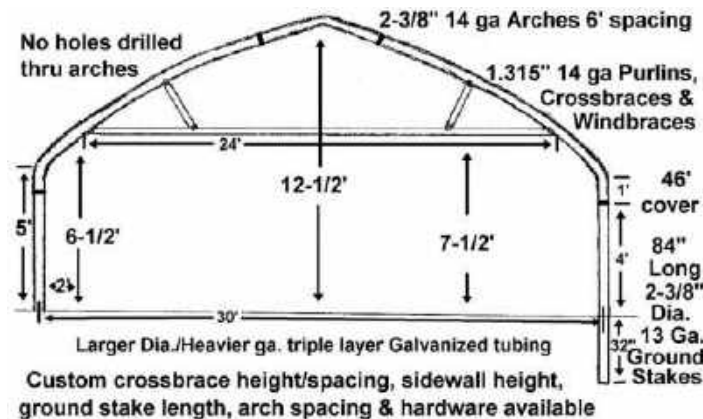

This 30' frame includes crosstie assembly on each arch except end arches, and has 5 purlins and 4 wind braces. Hardware: cross connectors & pipe straps for fastening purlins, bolts & pipe straps for fastening purlins, baseboard, end wall brackets, assembly instructions and stake driver.

Size	Price
30' x 48'	\$3,250.00
30' x 72'	\$4,700.00
30' x 96'	\$6,000.00
30' x 144'	\$8,750.00

30' Northern Gothic Greenhouse

This 30' frame has same specifications as the one to the left except: 1.9" 13 gauge arches with 6" long swedge to insert into ground stake. This makes it stronger and capable of carrying more snow load. Recommended for heavy snow fall areas.

Size	Price	Optional 5½' Sidewall add:	Optional W bracing for crossties
30' x 48'	\$3,900.00	\$78.00	\$290.00
30' x 72'	\$5,500.00	\$114.00	\$440.00
30' x 96'	\$7,065.00	\$150.00	\$590.00
30' x 144'	\$10,350.00	\$222.00	\$895.00

34' Gothic Greenhouse, 4' arch spacing

This 34' frame has same specifications as the 30' to the left except: 7 purlins & 1.9" 13 gauge arches with 6" long swedge to insert into ground stake. It also comes standard with W bracing on the crossties (4 braces per crosstie). Uses 50' wide plastic

Size	Price	Optional 5½' Sidewall add:
34' x 48'	\$4,710.00	\$78.00
34' x 72'	\$6,750.00	\$114.00
34' x 96'	\$8,740.00	\$150.00
34' x 144'	\$12,825.00	\$222.00



34' Gothic Greenhouse, 5' Straight Sides

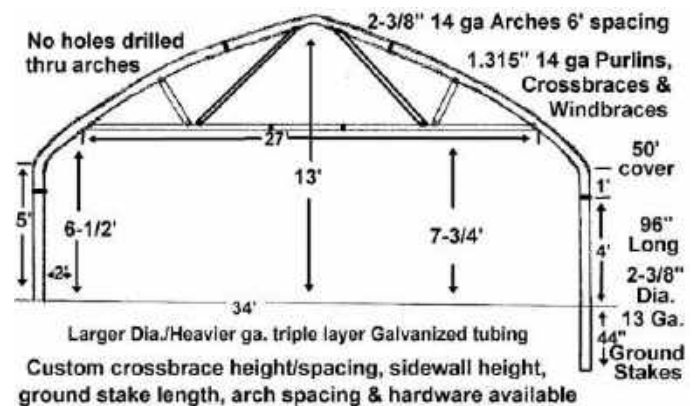

This 34' frame includes crosstie assembly on each arch except end arches, and has 7 purlins and 4 wind braces. Hardware: cross connectors & pipe straps for fastening purlins, bolts & pipe straps for baseboard, end wall brackets, assembly instructions and stake driver.

Size	Price
34' x 72'	\$6,220.00
34' x 96'	\$7,900.00
34' x 144'	\$11,300.00
34' x 198'	\$15,100.00



Greenhouse (High Tunnel) Sample Packages

These high tunnel packages include two layers of plastic, inflation blower, plastic for end walls, and two roll-up sides. Frame includes all hardware & parts required for assembly including lugs & straps to fasten baseboard and a detailed construction manual.

Some other basic items that you will need to obtain include: Doors, Treated lumber to frame end walls (2x4 and/or 4x4) and for baseboards (2x8 or 2x10). You may also need electrical wiring, propane and water plumbing.

Add-ons we stock: Roll-Lock to secure roll-up pipe (recommended if heating), heaters, exhaust and circulation fans, intake shutters, black ground cover, polycarbonate twin wall sheeting, temperature alarms, purlins for hanging baskets, etc.

These are sample quotes and can be customized to your requirements. Contact us for custom quotes or quotes on other sizes.

Prices subject to change without notice. Call to request a quote or check availability.

21' x 48'

Qty	Unit	Item #	Item Description	Rate	Amount
1	ea	C2148	21x48' Straight Side Peaked Greenhouse Frame	2,020.00	2,020.00
1	ea	T4838	36x100' 6 Mil 4 Year Greenhouse Plastic	324.00	324.00
1	ea	T4614	14x100' 6 Mil 4 Year Greenhouse Plastic	126.00	126.00
1	ea	GGA500	3/4"x500 Batten Tape	38.00	38.00
1	ea	GEA1480	4 Bolt Blower KIT 148 CFM w/ Cord 115V	58.00	58.00
1	ea	GEA1481	4 Bolt Mounting Kit	17.00	17.00
9	Pcs	GFA1	8' Single WireLock Base	6.30	56.70
8	Pcs	GFA1080	12" DOUBLE WireLock Base	21.00	168.00
2	100 Pcs	GFA2121	1" #12 SS Self Drilling TEK Screw	10.50	21.00
2	50/RUND	GFA104	4' ZigZag Wire	44.00	88.00
2	ea	GFA104	GCS:1B 5:1 GearCrank w/1.315" adapter	84.00	168.00
2	ea	GFA104P	6' Guide Pipe Assy. for 5:1 Gearcrank	16.00	32.00
12	ea	GFA5RH	Aluminum Rope Hook	1.20	14.40
14	ea	ZES04003	4" Eye Screw 5/16"	0.85	11.90
1	350' Roll	GFA5CR	1/4" Rope Neobraid Black 100% polyester	39.00	39.00
50	ea	FC 010	1" Fabric Clip, Fits 1-3/8" OD Pipe	0.80	40.00
8	ea	GGP1312175	1-3/8" 17ga 147' Swedged Purlin Pipe	12.55	101.20
1	ea	GFA5RPH2X	Roll-pipe Hanger for 2" Baseboard, 9/PK	19.00	19.00
Total:				\$ 3,342.20	

30' x 72'

Qty	Unit	Item #	Item Description	Rate	Amount
1	ea	C3072	30x72' Gothic Greenhouse Frame, 4' Sidewall	4,830.00	4,830.00
1	ea	T4848150	48x150' 6 Mil 4 Year Greenhouse Plastic	648.00	648.00
1	ea	T4614	14x100' 6 Mil 4 Year Greenhouse Plastic	126.00	126.00
1	ea	GGA500	3/4"x500 Batten Tape	38.00	38.00
1	ea	GEA1480	4 Bolt Blower KIT 148 CFM w/ Cord 115V	72.00	72.00
1	ea	GEA1481	4 Bolt Mounting Kit	17.00	17.00
8	Pcs	GFA10	12" Single WireLock Base	9.45	75.60
12	Pcs	GFA1080	12" DOUBLE WireLock Base	21.00	252.00
2	100 Pcs	GFA2121	1" #12 SS Self Drilling TEK Screw	10.50	21.00
2	50/RUND	GFA104	4' ZigZag Wire	44.00	88.00
2	ea	GFA104	GCS:1B 5:1 GearCrank w/1.315" adapter	84.00	168.00
2	ea	GFA104P	6' Guide Pipe Assy. for 5:1 Gearcrank	16.00	32.00
1	25/PK	GFA5RH	Aluminum Rope Hook	25.00	25.00
20	ea	ZES04003	4" Eye Screw 5/16"	0.85	17.00
1	350' Roll	GFA5CR	1/4" Rope Neobraid Black 100% polyester	39.00	39.00
24	ea	FC 010	1" Fabric Clip, Fits 1-3/8" OD Pipe	0.80	59.20
12	ea	GGP1312175	1-3/8" 17ga 147' Swedged Purlin Pipe	12.00	144.00
1	ea	GFA5RPH2X	Roll-pipe Hanger for 2" Baseboard, 9/PK	19.00	19.00
Total:				\$ 6,714.80	

21' x 72'

Qty	Unit	Item #	Item Description	Rate	Amount
1	ea	C2172	21x72' Straight Side Peaked Greenhouse Frame	2,840.00	2,840.00
1	ea	T4838150	36x150' 6 Mil 4 Year Greenhouse Plastic	486.00	486.00
1	ea	T4614	14x100' 6 Mil 4 Year Greenhouse Plastic	126.00	126.00
1	ea	GGA500	3/4"x500 Batten Tape	38.00	38.00
1	ea	GEA1480	4 Bolt Blower KIT 148 CFM w/ Cord 115V	72.00	72.00
1	ea	GEA1481	4 Bolt Mounting Kit	17.00	17.00
9	Pcs	GFA1	8' Single WireLock Base	6.30	56.70
12	Pcs	GFA1080	12" DOUBLE WireLock Base	21.00	252.00
2	100 Pcs	GFA2121	1" #12 SS Self Drilling TEK Screw	10.50	21.00
2	50/RUND	GFA104	4' ZigZag Wire	44.00	88.00
2	ea	GFA104	GCS:1B 5:1 GearCrank w/1.315" adapter	84.00	168.00
2	ea	GFA104P	6' Guide Pipe Assy. for 5:1 Gearcrank	16.00	32.00
1	25/PK	GFA5RH	Aluminum Rope Hook	25.00	25.00
20	ea	ZES04003	4" Eye Screw 5/16"	0.85	17.00
1	350' Roll	GFA5CR	1/4" Rope Neobraid Black 100% polyester	39.00	39.00
24	ea	FC 010	1" Fabric Clip, Fits 1-3/8" OD Pipe	0.80	59.20
12	ea	GGP1312175	1-3/8" 17ga 147' Swedged Purlin Pipe	12.00	144.00
1	ea	GFA5RPH2X	Roll-pipe Hanger for 2" Baseboard, 9/PK	19.00	19.00
Total:				\$ 4,499.90	

30' x 96'

Qty	Unit	Item #	Item Description	Rate	Amount
1	ea	C3096	30x96' Gothic Greenhouse Frame, 4' Sidewall	6,250.00	6,250.00
1	ea	T4640	48x100' 6 Mil 4 Year Greenhouse Plastic	432.00	432.00
1	ea	TES46	48x100' Infrared 6 Mil 4 Year Greenhouse Plastic	480.00	480.00
1	ea	T4614	14x100' 6 Mil 4 Year Greenhouse Plastic	126.00	126.00
1	ea	GGA500	3/4"x500 Batten Tape	38.00	38.00
1	ea	GEA1480	4 Bolt Blower KIT 148 CFM w/ Cord 115V	72.00	72.00
1	ea	GEA1481	4 Bolt Mounting Kit	17.00	17.00
8	Pcs	GFA10	12" Single WireLock Base	9.45	75.60
16	Pcs	GFA1080	12" DOUBLE WireLock Base	21.00	336.00
2	100 Pcs	GFA2121	1" #12 SS Self Drilling TEK Screw	10.50	31.50
2	50/RUND	GFA104	4' ZigZag Wire	44.00	88.00
2	ea	GFA104	GCS:1B 5:1 GearCrank w/1.315" adapter	84.00	168.00
2	ea	GFA104P	6' Guide Pipe Assy. for 5:1 Gearcrank	16.00	32.00
1	25/PK	GFA5RH	Aluminum Rope Hook	25.00	25.00
20	ea	ZES04003	4" Eye Screw 5/16"	0.85	22.10
1	350' Roll	GFA5CR	1/4" Rope Neobraid Black 100% polyester	39.00	39.00
100	ea	FC 010	1" Fabric Clip, Fits 1-3/8" OD Pipe	0.75	75.00
16	ea	GGP1312175	1-3/8" 17ga 147' Swedged Purlin Pipe	12.00	192.00
1	ea	GFA5RPH2X	Roll-pipe Hanger for 2" Baseboard, 9/PK	19.00	19.00
Total:				\$ 8,562.20	

21' x 96'

Qty	Unit	Item #	Item Description	Rate	Amount
1	ea	C2196	21x96' Straight Side Peaked Greenhouse Frame	3,650.00	3,650.00
1	ea	T4836	36x100' 6 Mil 4 Year Greenhouse Plastic	324.00	324.00
1	ea	TES36	36x100' Infrared 6 Mil 4 Year Greenhouse Plastic	360.00	360.00
1	ea	T4614	14x100' 6 Mil 4 Year Greenhouse Plastic	126.00	126.00
1	ea	GGA500	3/4"x500 Batten Tape	38.00	38.00
1	ea	GEA1480	4 Bolt Blower KIT 148 CFM w/ Cord 115V	72.00	72.00
1	ea	GEA1481	4 Bolt Mounting Kit	17.00	17.00
9	Pcs	GFA1	8' Single WireLock Base	6.30	56.70
16	Pcs	GFA1080	12" DOUBLE WireLock Base	21.00	336.00
2	100 Pcs	GFA2121	1" #12 SS Self Drilling TEK Screw	10.50	31.50
2	50/RUND	GFA104	4' ZigZag Wire	44.00	88.00
2	ea	GFA104	GCS:1B 5:1 GearCrank w/1.315" adapter	84.00	168.00
2	ea	GFA104P	6' Guide Pipe Assy. for 5:1 Gearcrank	16.00	32.00
1	25/PK	GFA5RH	Aluminum Rope Hook	25.00	25.00
26	ea	ZES04003	4" Eye Screw 5/16"	0.85	22.10
1	350' Roll	GFA5CR	1/4" Rope Neobraid Black 100% polyester	39.00	39.00
100	ea	FC 010	1" Fabric Clip, Fits 1-3/8" OD Pipe	0.75	75.00
16	ea	GGP1312175	1-3/8" 17ga 147' Swedged Purlin Pipe	12.00	192.00
1	ea	GFA5RPH2X	Roll-pipe Hanger for 2" Baseboard, 9/PK	19.00	19.00
Total:				\$ 5,715.30	

30' Gothic Greenhouse (or High Tunnel) Frame

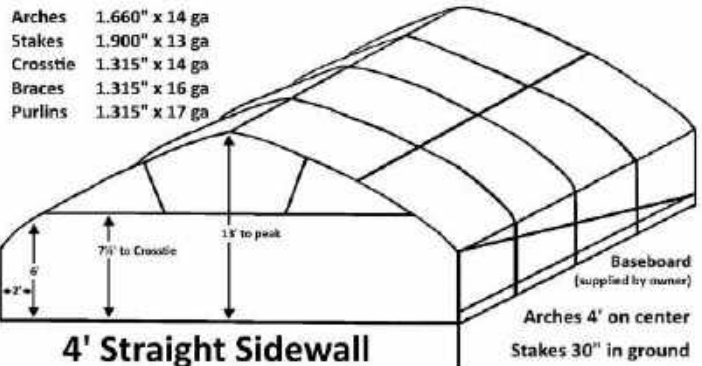

See page 46 and 47 for more frame specifications.

21' Peaked High Tunnels:

- 10½' to peak, 5' Straight Sidewall.
- Arches: 1.66" x 14 gauge, Stakes: 1.9" x 13 gauge.
- Purlins & wind braces: 1.315" x 17 gauge
- Crossties are optional.



Wooden Trellises

Clematis trainers made with 3/8" x 3/8" neatly stapled pressure treated wood. Can be used to support a variety of vines and climbing plants.

We can also get other sizes and styles of wooden and wire plant supports.

For details on other wooden sizes and styles visit www.woodtrellisdesigns.net



Item #	Description	1-5 Pk	6+ Pk
TRE24WT	24" Tapered Wood Trellis, 25/Pack	\$38.50	\$37.00
TRE30WT	30" Tapered Wood Trellis, 25/Pack	\$45.50	\$44.00

Plant Support Rings

Designed to clip to pot rims. Call for prices. Pieces per case vary from 500-3000 pcs.

Sizes available for injection molded pots:
4, 4.5, 5, 6, 7, 8, 9, 10, 12 and 14 inch diameter.
Sizes available for coex/thermoformed pots:
6, 7, 8, 9 and 10 inch diameter.



Long Straight Snip - Stainless Steel

Long, straight, pointed blade for a wide range of applications. Corrosion-resistant SS blades prevent rusting, are easier to clean. Unobtrusive leather strap lock.



Item #	Description	Price
HTAG4930SS	Long Straight Snip, Stainless Steel	\$9.50

Post Planters

The Post Planter is a heavy duty pot made from PVC, for many years of use. It is the perfect dress up for that bare corner on your deck railing, or to brighten up that boring picket fence in your front yard. The square bird bath adds flare. There are many possible combinations.

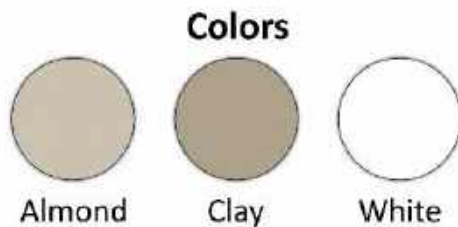

PVC fencing colors. White, unless specified otherwise. For almond add **A** to item number. For clay add **C** to item number.
Example: PP 03C = Clay Pot

Item #	Description	Each	Case of 15 pcs
PP 03	White Post Planter, Pot	\$14.50	\$195.00 = \$13.00 each
Item #	Description	Each	Case of 4 pcs
PP 04	White 4" Post Extension	\$16.50	\$60.00 = \$15.00 each
PP 05	White Bird Bath	\$15.00	\$54.00 = \$13.50 each
PP 06	White 30" Post Kit	\$49.50	\$188.00 = \$47.00 each



Fogit Greenhouse Sprayer

The Fogit Sprayer is an easy to use, low volume chemical applicator designed with smaller greenhouses in mind. It can easily apply a wide variety of chemical formulations using a highly concentrated spray solution. The nozzle generates micro-particles that fill the entire treatment area and ensure complete and even coverage of all plant surfaces. This method of applying chemical solutions eliminates costly run-off and reduces the amount of chemical needed. Air agitation—keeps chemicals in suspension.



Standard Treatment Area: Up to 5,000 sq. Ft. (7,000 sq ft with circulation fans). **Tank size:** approx. 7 Liters (7.4 quarts)
Compressor required: 4 CFM at 25 PSI (9 CFM for dual head)
Now standard with stainless steel head(s) and larger tank.

Item #	Description	Price
FGS01	Fogit Greenhouse Sprayer	\$448.00
FGS02	Fogit Greenhouse Sprayer, 2 nozzle	\$565.00
FGS110TE	110 VAC Electric Switch, Prewired Timer	\$99.00
FGS110TA	110 VAC Air Valve, Prewired Timer	\$225.00
FGS12TA	12 VDC Air Valve, Prewired Timer	\$225.00
FGS110C	110 volt Air Compressor W/Timer (For single nozzle Fogit only)	\$480.00

Floral Scissors

Stainless steel blades are serrated for easy, clean cuts, and separate for easy cleaning. Anti-Blister comfortable grips. For cutting and pruning plants.



Item #	Description	Price
HTFS3394	Floral Scissors, Stainless Steel	\$10.60



Nolt's Greenhouse Supplies
151 E Farmersville Rd
Ephrata, PA 17522
Phone: 717.354.8376

